

# **Per- and Polyfluoroalkyl Substances (PFAS) Exposure Assessment Technical Tools**

---

Centers for Disease Control and Prevention (CDC)  
Agency for Toxic Substances and Disease Registry (ATSDR)

July 2018



# PFAS Exposure Assessment Technical Tools (PEATT)

## Table of Contents

Chapter Number	Chapter Title	Page Range
<a href="#">1</a>	PFAS Exposure Assessment Framework: Using Serum Testing as a Component for Assessing Exposure in Communities with Drinking Water Contaminated with Per- and Polyfluoroalkyl Substances	1-1 – 1-11
<a href="#">2</a>	PFAS Exposure Assessment Technical Tools: Introduction	2-1 – 2-3
<a href="#">3</a>	PFAS Exposure Assessment in a Community: Sampling Strategy and Data Analysis Assistance	3-1 – 3-9
<a href="#">4</a>	PFAS Exposure Assessment Question Bank: Adults	4-1 – 4-11
<a href="#">5</a>	PFAS Exposure Assessment Question Bank: Child	5-1 – 5-8
<a href="#">6</a>	PFAS Exposure Assessment: Invitation Letter and Consent Form, Assent Form for Minors	6-1 – 6-8
<a href="#">7</a>	PFAS Exposure Assessment: Result Letters for Participants	7-1 – 7-14
<a href="#">8</a>	PFAS Exposure Assessment: Serum Collection Protocol	8-1 – 8-3
<a href="#">9</a>	PFAS Exposure Assessment: Non-Federal Laboratories That Measure PFAS	9-1
<a href="#">10</a>	Laboratory Procedure Manual	10-1 – 10-40
<a href="#">11</a>	PFAS Exposure Assessment: Know Your Audiences - Audience Outreach Materials for Environmental Exposures	11-1 – 11-6
<a href="#">12</a>	The Family Tree of Per- and Polyfluoroalkyl Substances for Environmental Health Professionals	12-1 – 12-2
<a href="#">13</a>	The Family Tree of Per- and Polyfluoroalkyl Substances	13-1 – 13-2
<a href="#">14</a>	An Overview of Per- and Polyfluoroalkyl Substances and Interim Guidance for Clinicians Responding to Patient Exposure Concerns	14-1 – 14-11
<a href="#">15</a>	PFAS ToxGuide for Perfluoroalkyls	15-1 – 15-2
<a href="#">16</a>	Environmental Protection Agency References	16-1
<a href="#">Apx.</a>	Appendices	A-1

### Version Control Table

Version Number	Modified By	Modifications Made	Date Modified
4 (Current)	NCEH/ATSDR	Updated Chapters 2, 3, 4, 5, 6, 7, and 15	7/23/2018
3	NCEH/ATSDR	Table of Contents Added	7/18/2017
2	NCEH/ATSDR	PFAS Family Trees Added	6/19/2017
1	NCEH/ATSDR	Initial Version	6/1/2017

# Using Serum Testing as a Component for Assessing Exposure in Communities with Drinking Water Contaminated with Per- and Polyfluoroalkyl Substances

---

**This framework document is designed to help state health departments when measuring and evaluating community exposures to Per- and Polyfluoroalkyl substances (PFAS) in drinking water.**

In this framework, a statistically based approach to recruit, measure, and evaluate community exposures to PFAS includes:

- Biomonitoring (serum testing),
- Identifying exposure source(s), and
- Administering questionnaires to provide an assessment of exposure source(s) along with the magnitude and distribution of exposure in the community.

NOTE: This framework document does not assist in determining whether biomonitoring is appropriate or necessary. The decision to conduct biomonitoring should be based on specific circumstances of affected communities along with considerations related to human subjects' protections. Health departments need to consider that the approach described here will require identification of a funding source and specific staff expertise. CDC and ATSDR can provide technical assistance to health departments to help develop and execute a biomonitoring effort. Finally, this framework may not be applicable to all proposed biomonitoring efforts; that is, this framework should not preclude other approaches to biomonitoring.

Centers for Disease Control and Prevention (CDC)  
Agency for Toxic Substances and Disease Registry (ATSDR)

July 2018

## Introduction

---

CDC's National Center for Environmental Health (NCEH) and the Agency for Toxic Substances and Disease Registry (ATSDR) work to protect communities from exposure to harmful chemicals.

PFAS have been detected in numerous public and private drinking water supplies throughout the United States. State and local health departments requested CDC and ATSDR's assistance on how to best assess exposure to PFAS in communities where PFAS contamination of water is known or reasonably expected.

CDC and ATSDR understand and acknowledge that individuals may want to know the level of PFAS in their blood. However, conducting biomonitoring on all individuals in a community may not be feasible. The statistically based, scientific approach outlined in this framework allows for a practical and feasible approach for assessing potential community exposures to PFAS and will provide estimated serum PFAS levels in the community members who were not tested. If the state health or other entity opts for an alternate approach, we suggest use of statistical participant selection/recruitment methods to ensure results can be generalized to the affected community.

## 8- Step Approach to Assess Community Exposures to PFAS<sup>1,2</sup>

---

CDC/ATSDR suggest the following approach to assess community exposure to PFAS from contaminated drinking water.

- 1) Evaluate existing data on PFAS in drinking water and assess potential current or past community exposure. Consider whether additional exposure pathway data are important (e.g., consumer products, dietary sources including fish from PFAS-contaminated water bodies, crops grown in fields amended with contaminated biosolids, and occupational exposure). [ATSDR's Public Health Assessment Guidance Manual](#) provides helpful information for evaluating existing data.
- 2) If PFAS was or is expected to be elevated in drinking water compared to EPA's Lifetime Health Advisory (HA) or state-specific threshold levels, identify variables expected to be associated with increased exposure within the population. Examples of variables can include people in a particular geographic area where elevated PFAS water concentrations existed in the past or currently exist, or people who have been drinking contaminated water over a long period of time, etc. Develop a protocol that describes how these factors will be assessed, and include provision of the variables in steps number 3 through 7 below.<sup>2</sup>
- 3) Develop and implement a communications plan.
- 4) Develop a questionnaire that includes demographics, geographic information, and factors influencing exposure to PFAS in water and other potential sources of PFAS. The CDC/ATSDR PFAS Environmental Assessment Technical Tools (PEATT) provide a questionnaire example with core questions.

---

<sup>1</sup> A detailed description and approach is provided in the NCEH/ATSDR PFAS Environmental Assessment Technical Tools (PEATT) for PFAS evaluations.

<sup>2</sup> Human subjects' protection policies and procedures should be followed.

- 5) Identify laboratories (with appropriate quality control assurance) capable of performing water PFAS measurements using [EPA Method 537](#). Likewise, identify a quality laboratory to perform serum PFAS measurements. The PEATT provides serum sample collection, storage, and analysis information.
- 6) Develop a statistically based, community sampling design that will provide information about the range of PFAS exposures in an affected community. Ensure that higher exposure groups and other subgroups of interest are adequately sampled.<sup>3</sup>
  - a) People likely to have higher exposure to PFAS
  - b) Relevant demographic groups (e.g., children and adults; males and females; race/ethnic groups)
- 7) Administer the questionnaire, collect blood samples, and, if exposures are ongoing, collect home tap water or other appropriate environmental samples.
- 8) Analyze data from step 6 to do the following.
  - a) Determine PFAS blood level estimates and the uncertainty for those estimates for the community as a whole and for subgroups such as:
    - Groups considered at risk for higher exposures
    - Children and adults
    - Males and females
    - Race/ethnic groups (if relevant)
    - Persons in different economic strata
    - Different neighborhoods
    - Different drinking water sources
    - Other
  - b) Using questionnaire data, water PFAS information, and serum PFAS levels from the targeted community exposure assessment, develop the best predictive multivariate model of serum PFAS levels. This model can assist in predicting serum PFAS levels for persons who have water PFAS measurements but have not had their blood tested.

## Additional Considerations

---

**Pilot sampling.** A community may be particularly concerned about exposure and want to know the magnitude of their PFAS body burden right away. A preliminary or pilot investigation may be useful while the exposure assessment planning steps described above are ongoing. If so, based on known exposure sources and length of time exposed, select a small number of individuals (e.g., 30–50) thought to have the highest exposures. While not a statistically based sample, the results may provide rapid preliminary information on a subset of community

---

<sup>3</sup> The approach described in the NCEH/ATSDR PEATT is appropriate for exposure assessment of a general population with known or suspected exposure to PFAS. Oversampling of subgroups that can be accomplished by simple stratification is also included. However, for some subgroups of interest, such as children or pregnant women, consider more complex statistical sampling approaches designed to measure blood PFAS exposure levels of a targeted population of interest.

members suspected to be in the upper range of serum PFAS levels. These results may inform the community based sampling design.

NOTE: This pilot sample is not representative of the general community and, therefore, is not meant to be a substitute for the statistically based, community sample described above in the 8-step approach.

**Exposure and health effects.** The approaches described above are exposure assessments and not epidemiologic studies. A study may include a comparison group, an expanded health effects questionnaire, additional laboratory data relating to potential health effects and, potentially, a medical records review. However, biomonitoring results from the community exposure assessment may be compared to biomonitoring results in exposure/health effects studies done in other population groups.

**CDC and ATSDR role.** If requested, CDC and ATSDR will provide technical assistance to health departments to develop and execute this exposure assessment approach.

### Answers to Commonly Asked Question about PFAS and Biomonitoring

---

- A scientifically designed community investigation allows for an assessment of the community's exposure profile in a timely manner (e.g., typically less than about two years for the community report, depending on logistics, funding, etc.). This includes information about high and low exposure estimates, PFAS levels in groups of special concern (e.g., children), and how personal factors such as drinking water source, length of residence, age, and occupation may affect results.
- The information derived from this approach can potentially be used to design a health study to monitor for possible health effects in these groups, even if not all of the individuals within these groups participated in biomonitoring.

#### What advice can be given to individuals who were not selected for biomonitoring?

- Whether selected or not for biomonitoring, individuals should take practical steps to reduce current exposure to PFAS. For example, use alternative water sources if advised by the local health officials.
- The community biomonitoring report should provide information about the range of serum PFAS levels and may provide information on how the levels vary among different population groups in the community. From these data, people who were not tested should be able to get an estimate of their likely serum PFAS level.
- If for some reason an individual still desires personal serum PFAS results, they should be encouraged to seek advice from their health care provider and other professionals (e.g., regional Pediatric Environmental Health Specialty Units or PEHSUs).<sup>4</sup>

#### How can individual serum PFAS concentrations be interpreted?

Serum PFAS concentrations for individuals 3 years of age and older can be compared to U.S. population results from CDC's National Health and Nutrition Examination Survey (NHANES). Serum PFAS have been measured in NHANES since 1999. As part of the ongoing NHANES, serum PFAS are measured in a one third sample of participants, ages 12 and older. Population-based reference values are available by age group (12–19 years, 20+ years), sex, and

---

<sup>4</sup> Clinical guidance for healthcare providers can be found at: <http://www.atsdr.cdc.gov/pfc/index.html>

race/ethnicity (non-Hispanic black, non-Hispanic white, Mexican American). Beginning in 2011, the racial/ethnic groups of Asian (e.g., non-Hispanic Asian) and all Hispanics were added. The most recent survey results (2011–2014) are included in Appendix A.

Typically, the 95th percentile is used as the upper end of the reference range for the U.S. population. For children 3 to 11 years old, serum PFAS measurements were made in NHANES 2013–2014 and provide recent national reference values.<sup>5</sup>

Biomonitoring sampling results cannot predict current or future health outcomes or diseases. That is, the results are not currently clinically actionable. Further, the biomonitoring results will not likely result in any different medical evaluations than just knowing or assuming that an individual was exposed to PFAS in contaminated drinking water above EPA health advisory levels in addition to other possible exposure sources (e.g., diet, occupation). There are no health-based screening levels for specific PFAS that clinicians can compare to the concentrations measured in blood samples. As a result, interpreting PFAS concentrations in individuals is limited in its use.\_\_\_\_\_

### For More Information

---

For more information about PFAS, toxicity and exposure assessment, and clinical guidance for healthcare providers, visit the CDC/ATSDR PFAS web page: <http://www.atsdr.cdc.gov/pfc/index.html>

For more information about biomonitoring and PFAS reference ranges for the U.S. population since 2001, visit CDC's national biomonitoring program web page (<http://www.cdc.gov/biomonitoring/>) and the Exposure Report web page (<https://www.cdc.gov/exposurereport/>).

---

<sup>5</sup> Per- and polyfluoroalkyl substances in sera from children 3 to 11 years of age participating in the National Health and Nutrition Examination Survey 2013–2014: <https://www.sciencedirect.com/science/article/pii/S1438463917305886>.

## Appendix A. Serum PFOS and PFOA in the U.S. Population, NHANES 2011–2014

### Serum Perfluorooctanoic acid (PFOA) (2011 - 2014)‡

Geometric mean and selected percentiles of serum concentrations (in µg/L) for the U.S. population from the National Health and Nutrition Examination Survey.

Survey mean	Sample years‡	Geometric		Selected percentiles								50th size	
		(95% conf. interval)		(95% confidence interval)									
<b>50th</b>													
<b>75th</b>													
<b>90th</b>													
<b>95th</b>													
<b>Total</b>	11-12	<b>2.08</b>	(1.95-2.22)	<b>2.08</b>	(1.96-2.26)	<b>3.03</b>	(2.76-3.27)	<b>4.35</b>	(3.82-4.85)	<b>5.68</b>	(5.02-6.49)	1904	
	13-14‡	<b>1.94</b>	(1.76-2.14)	<b>2.07</b>	(1.87-2.20)	<b>3.07</b>	(2.67-3.37)	<b>4.27</b>	(3.57-5.17)	<b>5.57</b>	(4.60-6.27)	2165	
<b>Age group</b>													
<b>12-19 years</b>	11-12	<b>1.80</b>	(1.71-1.91)	<b>1.74</b>	(1.67-1.89)	<b>2.41</b>	(2.17-2.62)		(2.68-3.19)	<b>3.59</b>	(2.93-4.25)	344	
	13-14‡	<b>1.66</b>	(1.50-1.84)	<b>1.67</b>	(1.37-1.97)	<b>2.20</b>	(1.97-2.57)	<b>2.93</b>	(2.57-3.40)	<b>3.47</b>	(2.87-4.37)	401	
<b>20 years and older</b>	11-12	<b>2.12</b>	(1.98-2.28)	<b>2.16</b>	(2.01-2.33)	<b>3.15</b>	(2.90-3.36)		(3.93-5.25)	<b>5.94</b>	(5.34-7.45)	1560	
	13-14‡	<b>1.98</b>	(1.79-2.19)	<b>2.07</b>	(1.90-2.27)	<b>3.17</b>	(2.77-3.47)	<b>4.64</b>	(3.70-5.27)	<b>5.60</b>	(4.67-6.40)	1764	
<b>Gender</b>													
<b>Males</b>	11-12	<b>2.37</b>	(2.22-2.53)	<b>2.38</b>	(2.26-2.56)	<b>3.25</b>	(3.00-3.56)		(4.11-5.02)	<b>5.62</b>	(4.85-6.20)	966	
	13-14‡	<b>2.29</b>	(2.09-2.50)	<b>2.37</b>	(2.17-2.57)	<b>3.27</b>	(2.87-3.60)	<b>4.61</b>	(3.77-5.60)	<b>5.67</b>	(4.67-6.27)	1031	
<b>Females</b>	11-12	<b>1.84</b>	(1.68-2.01)	<b>1.78</b>	(1.62-1.98)	<b>2.65</b>	(2.34-3.14)		(3.36-4.99)	<b>5.68</b>	(4.33-8.45)	938	
	13-14‡	<b>1.66</b>	(1.48-1.87)	<b>1.67</b>	(1.47-1.87)	<b>2.67</b>	(2.27-3.07)	<b>3.91</b>	(3.37-4.70)	<b>5.07</b>	(4.07-6.70)	1134	
<b>Race/ethnicity</b>													
<b>Mexican Americans</b>	11-12	<b>1.66</b>	(1.37-2.02)	<b>1.71</b>	(1.32-2.23)	<b>2.43</b>	(1.98-2.98)		(2.43-4.48)	<b>4.08</b>	(2.98-6.15)	211	
	13-14‡	<b>1.36</b>	(1.25-1.47)	<b>1.37</b>	(1.27-1.47)	<b>1.97</b>	(1.87-2.10)	<b>3.38</b>	(2.40-3.10)	<b>3.17</b>	(2.57-3.77)	332	
<b>Non-Hispanic blacks</b>	11-12	<b>1.80</b>	(1.71-1.90)	<b>1.94</b>	(1.76-2.09)	<b>2.82</b>	(2.65-2.95)		(3.51-4.40)	<b>5.11</b>	(4.40-5.79)	485	
	13-14‡	<b>1.52</b>	(1.34-1.73)	<b>1.67</b>	(1.37-1.97)	<b>2.57</b>	(2.17-2.97)	<b>3.94</b>	(3.07-4.50)	<b>4.60</b>	(3.40-5.77)	455	
<b>Non-Hispanic whites</b>	11-12	<b>2.25</b>	(2.05-2.47)	<b>2.25</b>	(1.98-2.48)	<b>3.21</b>	(2.90-3.50)		(3.95-5.35)	<b>6.20</b>	(5.34-7.74)	666	
	13-14‡	<b>2.20</b>	(1.91-2.52)	<b>2.27</b>	(1.97-2.67)	<b>3.37</b>	(2.77-3.77)	<b>4.68</b>	(3.77-5.67)	<b>5.77</b>	(4.80-6.87)	861	
<b>All Hispanics</b>	11-12	<b>1.70</b>	(1.48-1.95)	<b>1.79</b>	(1.59-1.95)	<b>2.46</b>	(2.15-2.91)		(2.95-4.48)	<b>4.70</b>	(3.87-5.94)	406	
	13-14‡	<b>1.45</b>	(1.33-1.59)	<b>1.47</b>	(1.37-1.67)	<b>2.10</b>	(1.97-2.40)	<b>3.60</b>	(2.67-3.27)	<b>3.47</b>	(3.17-3.97)	537	
<b>Asians</b>	11-12	<b>2.08</b>	(1.83-2.36)	<b>2.21</b>	(2.04-2.27)	<b>2.92</b>	(2.55-3.45)		(3.42-5.79)	<b>5.79</b>	(4.93-8.91)	291	
	13-14‡	<b>1.97</b>	(1.75-2.23)	<b>1.87</b>	(1.67-2.27)	<b>2.97</b>	(2.47-3.57)	<b>4.66</b>	(3.97-5.77)	<b>5.90</b>	(5.00-6.40)	234	

Limit of detection (LOD, see Data Analysis section) for Survey year 11-12 is 0.1.

‡See Calculation of PFOS and PFOA as the

Sum of Isomers for additional information about Survey years 2013-2014.

Source:

*The National Report on Human Exposure to Environmental Chemicals, Updated Tables, December 2016.*

Complete data tables for this and other chemicals measured in the U.S. population are available at:

<https://www.cdc.gov/exposurereport/>.



## Exposure Assessment Framework

### Serum Perfluorooctane sulfonic acid (PFOS) (2011 - 2014)‡

Geometric mean and selected percentiles of serum concentrations (in µg/L) for the U.S. population from the National Health and Nutrition Examination Survey.

Survey mean	Sample years‡	Geometric		Selected percentiles								50th size
		95% conf. interval)	(95% confidence interval)	50th	75th	90th	95th	95th	95th	95th	95th	
Total	11-12	<b>6.31</b>	(5.84-6.82)	<b>6.53</b>	(5.99-7.13)	<b>10.5</b>	(9.78-11.1)	<b>15.7</b>	(14.7-17.5)	<b>21.7</b>	(19.3-23.9)	1904
	13-14‡	<b>4.99</b>	(4.50-5.52)	<b>5.20</b>	(4.80-5.70)	<b>8.70</b>	(7.90-9.40)	<b>13.9</b>	(11.9-15.5)	<b>18.5</b>	(15.4-22.0)	2165
Age group												
	12-19 years											
	11-12	<b>4.16</b>	(3.70-4.68)	<b>4.11</b>	(3.48-4.65)	<b>5.90</b>	(5.14-7.25)		(6.49-10.8)	<b>10.8</b>	(8.52-14.2)	344
	13-14‡	<b>3.54</b>	(3.17-3.96)	<b>3.60</b>	(3.10-4.20)	<b>5.20</b>	(4.60-6.20)	<b>7.80</b>	(7.00-8.90)	<b>9.30</b>	(7.90-11.7)	401
20 years and older	11-12	<b>6.71</b>	(6.24-7.20)	<b>7.07</b>	(6.65-7.52)	<b>11.0</b>	(10.4-11.9)		(15.3-18.5)	<b>22.7</b>	(20.4-24.8)	1560
	13-14‡	<b>5.22</b>	(4.70-5.81)	<b>5.60</b>	(5.10-6.00)	<b>9.10</b>	(8.20-10.2)	<b>14.5</b>	(12.9-16.1)	<b>19.5</b>	(15.8-23.0)	1764
Gender												
	Males											
	11-12	<b>7.91</b>	(7.19-8.70)	<b>8.31</b>	(7.35-9.15)	<b>12.5</b>	(11.4-13.5)		(15.7-21.4)	<b>24.1</b>	(22.2-28.5)	966
	13-14‡	<b>6.36</b>	(5.62-7.20)	<b>6.40</b>	(5.70-7.30)	<b>10.2</b>	(8.70-11.5)	<b>15.5</b>	(13.2-19.8)	<b>22.1</b>	(16.7-26.9)	1031
Females	11-12	<b>5.10</b>	(4.70-5.53)	<b>5.27</b>	(4.67-5.64)	<b>8.57</b>	(7.87-9.30)		(11.0-14.9)	<b>17.5</b>	(14.9-20.5)	938
	13-14‡	<b>3.96</b>	(3.60-4.35)	<b>4.00</b>	(3.60-4.60)	<b>7.20</b>	(6.40-7.70)	<b>11.8</b>	(9.70-13.6)	<b>15.1</b>	(13.9-17.3)	1134
Race/ethnicity												
	Mexican Americans											
	11-12	<b>4.79</b>	(4.07-5.64)	<b>5.18</b>	(3.92-6.33)	<b>7.91</b>	(6.18-9.48)		(8.50-12.6)	<b>12.1</b>	(10.0-14.4)	211
	13-14‡	<b>3.47</b>	(2.90-4.16)	<b>3.70</b>	(3.00-4.40)	<b>5.20</b>	(4.60-6.40)	<b>8.80</b>	(6.40-10.3)	<b>10.8</b>	(9.20-11.8)	332
Non-Hispanic blacks	11-12	<b>6.35</b>	(5.41-7.46)	<b>6.57</b>	(5.71-7.65)	<b>11.3</b>	(9.74-13.9)		(13.9-31.3)	<b>30.7</b>	(21.6-45.1)	485
	13-14‡	<b>5.32</b>	(4.12-6.88)	<b>5.30</b>	(4.30-6.80)	<b>10.2</b>	(7.60-13.7)	<b>17.4</b>	(12.4-24.5)	<b>24.5</b>	(16.3-39.7)	455
Non-Hispanic whites	11-12	<b>6.71</b>	(6.15-7.32)	<b>6.83</b>	(6.07-7.73)	<b>10.7</b>	(9.89-12.2)		(14.8-18.1)	<b>21.3</b>	(18.7-23.5)	666
	13-14‡	<b>5.31</b>	(4.72-5.98)	<b>5.70</b>	(5.10-6.40)	<b>8.90</b>	(8.20-9.90)	<b>14.1</b>	(12.2-15.6)	<b>18.0</b>	(15.5-20.4)	861
All Hispanics	11-12	<b>4.63</b>	(3.86-5.55)	<b>5.18</b>	(4.41-6.19)	<b>8.10</b>	(6.64-9.78)		(9.96-12.6)	<b>13.4</b>	(11.5-16.1)	406
	13-14‡	<b>3.51</b>	(3.09-3.98)	<b>3.70</b>	(3.20-4.20)	<b>5.50</b>	(4.90-6.40)	<b>8.80</b>	(8.00-9.70)	<b>10.8</b>	(9.70-12.1)	537
Asians	11-12	<b>7.10</b>	(5.80-8.68)	<b>7.53</b>	(5.96-9.25)	<b>12.6</b>	(10.8-17.0)		(19.1-33.3)	<b>35.1</b>	(26.4-42.3)	291
	13-14‡	<b>6.18</b>	(5.08-7.52)	<b>6.30</b>	(5.00-7.90)	<b>13.2</b>	(9.40-15.4)	<b>23.8</b>	(15.2-33.9)	<b>33.6</b>	(20.1-69.0)	234

Limit of detection (LOD, see Data Analysis section) for Survey year 11-12 is 0.2.

‡. See Calculation of PFOS and PFOA as the Sum of Isomers for additional information about Survey years 2013-2014.

Source:

*The National Report on Human Exposure to Environmental Chemicals, Updated Tables, December 2016.*

Complete data tables for this and other chemicals measured in the U.S. population are available at:

<https://www.cdc.gov/exposurereport/>.

## Appendix B. Special Sample of Serum PFAS in Children 3 to 11 Years Old, 2013–2014

### Serum Perfluorooctanoic acid (PFOA) (2013 - 2014)‡

Geometric mean and selected percentiles of serum concentrations (in µg/L) for the U.S. population from the National Health and Nutrition Examination Survey.

	Survey years	Geometric mean	Selected percentiles				Sample size
		(95% conf. interval)	(95% confidence interval)				
			50th	75th	90th	95th	
<b>Total</b>	13–14	<b>1.92</b> (1.75-2.12)	<b>1.94</b> (1.66-2.15)	<b>2.67</b> (2.42-2.88)	<b>3.53</b> (3.13-4.09)	<b>4.19</b> (3.62-5.47)	639
<b>Age group</b>							
3–5 years	13–14	<b>2.00</b> (1.75-2.29)	<b>1.80</b> (1.62-2.40)	<b>2.94</b> (2.66-3.28)	<b>4.14</b> (2.88-5.86)	<b>5.58</b> (3.28-7.02)	181
6–11 years	13–14	<b>1.89</b> (1.72-2.07)	<b>1.94</b> (1.68-2.14)	<b>2.53</b> (2.25-2.84)	<b>3.26</b> (2.97-3.68)	<b>3.84</b> (3.40-4.09)	458
<b>Gender</b>							
Males	13–14	<b>1.95</b> (1.76-2.15)	<b>1.90</b> (1.64-2.19)	<b>2.71</b> (2.39-3.26)	<b>3.62</b> (3.23-4.00)	<b>4.14</b> (3.41-5.86)	343
Females	13–14	<b>1.90</b> (1.68-2.14)	<b>1.94</b> (1.63-2.18)	<b>2.55</b> (2.30-2.80)	<b>3.30</b> (2.88-4.01)	<b>4.22</b> (3.07-5.47)	296
<b>Race/ethnicity</b>							
All Hispanics	13–14	<b>1.71</b> (1.56-1.88)	<b>1.68</b> (1.55-1.93)	<b>2.31</b> (2.05-2.60)	<b>2.91</b> (2.48-3.30)	<b>3.29</b> (2.86-4.00)	220
Other	13–14	<b>2.00</b> (1.79-2.23)	<b>1.99</b> (1.71-2.34)	<b>2.75</b> (2.50-3.16)	<b>3.72</b> (3.20-4.22)	<b>4.28</b> (3.79-5.86)	419

‡. See Calculation of PFOS and PFOA as the Sum of Isomers for additional information.

#### Source:

*The National Report on Human Exposure to Environmental Chemicals, Updated Tables, March 2018.* Complete data tables for this and other chemicals measured in the U.S. population are available at:

<https://www.cdc.gov/exposurereport/>.

**Serum Perfluorooctane sulfonic acid (PFOS) (2013–2014)‡**

Geometric mean and selected percentiles of serum concentrations (in µg/L) for the U.S. population from the National Health and Nutrition Examination Survey.

	Survey years	Geometric mean (95% conf. interval)	Selected percentiles (95% confidence interval)				Sample size
			50th	75th	90th	95th	
<b>Total</b>	13-14	<b>3.88</b> (3.53-4.27)	<b>3.75</b> (3.44-4.17)	<b>5.56</b> (4.83-6.33)	<b>7.99</b> (7.02-9.53)	<b>11.0</b> (9.03-12.4)	639
<b>Age group</b>							
3-5 years	13-14	<b>3.38</b> (3.04-3.77)	<b>3.41</b> (2.84-3.78)	<b>4.78</b> (3.98-6.32)	<b>7.18</b> (5.50-8.71)	<b>8.82</b> (7.18-11.0)	181
6-11 years	13-14	<b>4.15</b> (3.76-4.58)	<b>4.02</b> (3.54-4.45)	<b>5.77</b> (5.10-6.43)	<b>8.78</b> (6.75-11.8)	<b>12.4</b> (9.32-14.1)	458
<b>Gender</b>							
Males	13-14	<b>4.07</b> (3.56-4.65)	<b>4.13</b> (3.44-4.76)	<b>6.19</b> (5.29-7.18)	<b>8.78</b> (7.18-11.8)	<b>11.8</b> (8.01-15.4)	343
Females	13-14	<b>3.70</b> (3.38-4.06)	<b>3.54</b> (3.24-3.96)	<b>4.88</b> (4.45-5.70)	<b>7.02</b> (6.33-8.71)	<b>9.44</b> (7.17-12.0)	296
<b>Race/ethnicity</b>							
All Hispanics	13-14	<b>3.53</b> (3.13-3.99)	<b>3.41</b> (2.95-3.84)	<b>4.71</b> (4.13-5.65)	<b>7.60</b> (5.43-9.44)	<b>9.32</b> (6.50-11.0)	220
Other	13-14	<b>4.01</b> (3.62-4.44)	<b>3.96</b> (3.44-4.48)	<b>5.97</b> (5.02-6.49)	<b>8.06</b> (6.98-11.3)	<b>12.0</b> (9.10-13.6)	419

‡See Calculation of PFOS and PFOA as the Sum of Isomers for additional information.

Source:

*The National Report on Human Exposure to Environmental Chemicals, Updated Tables, March 2018.* Complete data tables for this and other chemicals measured in the U.S. population are available at:

<https://www.cdc.gov/exposurereport/>.

## Exposure Assessment Framework

### Serum Perfluorononanoic acid (PFNA) (2013–2014)

Geometric mean and selected percentiles of serum concentrations (in µg/L) for the U.S. population from the National Health and Nutrition Examination Survey.

	Survey years	Geometric mean (95% conf. interval)	Selected percentiles (95% confidence interval)				Sample size
			50th	75th	90th	95th	
<b>Total</b>	13-14	<b>.794</b> (.681-.926)	<b>.700</b> (.610-.820)	<b>1.08</b> (.920-1.35)	<b>2.03</b> (1.29-3.42)	<b>3.26</b> (1.94-5.35)	639
<b>Age group</b>							
3-5 years	13-14	<b>.764</b> (.630-.928)	<b>.620</b> (.540-.760)	<b>1.11</b> (.840-1.53)	<b>2.03</b> (1.21-5.03)	<b>3.49</b> (1.41-7.95)	181
6-11 years	13-14	<b>.809</b> (.682-.960)	<b>.750</b> (.630-.860)	<b>1.07</b> (.920-1.38)	<b>1.98</b> (1.16-3.56)	<b>3.19</b> (1.55-4.88)	458
<b>Gender</b>							
Males	13-14	<b>.829</b> (.686-1.00)	<b>.720</b> (.610-.850)	<b>1.10</b> (.890-1.59)	<b>2.34</b> (1.17-5.35)	<b>3.85</b> (1.72-6.93)	343
Females	13-14	<b>.759</b> (.638-.902)	<b>.680</b> (.570-.870)	<b>1.07</b> (.890-1.35)	<b>1.88</b> (1.21-2.84)	<b>2.58</b> (1.42-4.06)	296
<b>Race/ethnicity</b>							
All Hispanics	13-14	<b>.753</b> (.622-.912)	<b>.640</b> (.540-.760)	<b>1.03</b> (.790-1.53)	<b>1.98</b> (1.15-3.26)	<b>3.00</b> (1.59-9.32)	220
Other	13-14	<b>.808</b> (.681-.958)	<b>.720</b> (.600-.870)	<b>1.09</b> (.920-1.38)	<b>2.08</b> (1.34-3.47)	<b>3.46</b> (1.88-5.35)	419

Limit of detection (LOD, see Data Analysis section) for Survey year 13-14 is 0.1.

Source:

*The National Report on Human Exposure to Environmental Chemicals, Updated Tables, March 2018.* Complete data tables for this and other chemicals measured in the U.S. population are available at:

<https://www.cdc.gov/exposurereport/>.

**Serum Perfluorohexane sulfonic acid (PFHxS) (2013–2014)**

Geometric mean and selected percentiles of serum concentrations (in µg/L) for the U.S. population from the National Health and Nutrition Examination Survey.

	Survey years	Geometric mean (95% conf. interval)	Selected percentiles (95% confidence interval)				Sample size
			50th	75th	90th	95th	
<b>Total</b>	13-14	<b>.843</b> (.756-.939)	<b>.810</b> (.710-.900)	<b>1.24</b> (1.08-1.47)	<b>2.14</b> (1.62-2.81)	<b>3.12</b> (2.29-4.59)	639
<b>Age group</b>							
3-5 years	13-14	<b>.715</b> (.617-.828)	<b>.740</b> (.580-.830)	<b>1.04</b> (.920-1.24)	<b>1.55</b> (1.07-2.41)	<b>1.62</b> (1.31-3.66)	181
6-11 years	13-14	<b>.913</b> (.803-1.04)	<b>.850</b> (.730-.960)	<b>1.41</b> (1.13-1.65)	<b>2.33</b> (1.84-3.20)	<b>4.14</b> (2.33-6.42)	458
<b>Gender</b>							
Males	13-14	<b>.933</b> (.813-1.07)	<b>.930</b> (.770-1.02)	<b>1.54</b> (1.24-1.59)	<b>2.32</b> (1.64-3.70)	<b>3.73</b> (2.32-5.97)	343
Females	13-14	<b>.757</b> (.672-.853)	<b>.740</b> (.620-.830)	<b>1.03</b> (.930-1.19)	<b>1.65</b> (1.41-2.26)	<b>2.94</b> (1.75-3.74)	296
<b>Race/ethnicity</b>							
All Hispanics	13-14	<b>.787</b> (.697-.890)	<b>.740</b> (.640-.810)	<b>1.13</b> (1.01-1.39)	<b>2.20</b> (1.31-3.20)	<b>2.81</b> (1.88-5.89)	220
Other	13-14	<b>.862</b> (.761-.977)	<b>.840</b> (.710-.940)	<b>1.29</b> (1.08-1.55)	<b>2.14</b> (1.62-3.02)	<b>3.56</b> (2.32-4.74)	419

Limit of detection (LOD, see Data Analysis section) for Survey year 13-14 is 0.1.

Source:

*The National Report on Human Exposure to Environmental Chemicals, Updated Tables, March 2018.* Complete data tables for this and other chemicals measured in the U.S. population are available at:

<https://www.cdc.gov/exposurereport/>

# PFAS Exposure Assessment Technical Tools: Introduction

---

**Per- and Polyfluoroalkyl substances (PFAS) have been detected in drinking water supplies across the United States, raising some concerns about possible health risks. One way to understand exposure to PFAS is through biomonitoring. CDC/ATSDR created these tools to help state, local, tribal, and territorial health departments conduct biomonitoring activities (when the principal source of PFAS exposure is from drinking water).**

## **Use of PFAS Has Decreased, But People are Still Exposed**

---

Per- and polyfluoroalkyl substances (PFAS) are a large group of man-made chemicals that have been used since the 1950s. Use of some of these chemicals has greatly decreased in the United States over the last 10 years. Even though PFAS is no longer manufactured in the United States, people can still be exposed because PFAS can be found in certain drinking water sources, soil, food packaging and wrapping materials, homegrown vegetables grown in contaminated soil or watered with contaminated water, and outdoor air in areas with frequent PFAS use. PFAS can be found in certain consumer products such as stain resistant carpets, textiles and treated clothes.

Because of past episodes of environmental contamination, PFAS have been detected in numerous public and private drinking water supplies throughout the United States. As a result, public health agencies may be concerned about possible health risks from communities exposed to these drinking water supplies as well as other sources of PFAS contamination. The US Environmental Protection Agency (EPA) established a health advisory level of 70 parts per trillion for two PFAS chemicals (PFOA and PFOS—separately or combined) in drinking water (<https://www.epa.gov/ground-water-and-drinking-water/drinking-water-health-advisories-pfoa-and-pfos>).

These values may be revised as the science of PFAS progresses or if new values of concern are created for other PFAS. Finally, states may have their own advisory levels.

## **Blood Samples Can Help You Understand PFAS Exposure (with Limitations)**

---

One way to better characterize exposures in people is the use of biomonitoring. Biomonitoring is the measurement of the amount of a chemical inside the body from a blood or urine sample. PFAS biomonitoring is currently performed using blood samples only. Results from PFAS biomonitoring activities can be used to better understand exposures in a community or population, compare trends over time, provide a benchmark for activities that further reduce exposure, and monitor public health interventions.

An important limitation of using biomonitoring for PFAS exposure is that currently, there are no health-based screening levels for specific PFAS that clinicians can compare to the concentrations measured in blood samples. As a result, interpreting PFAS concentrations in an individual is limited in its use. However, our knowledge of these chemicals is advancing. Ongoing reassessment of new data will be necessary as progress is made in the understanding of PFAS and their associated health effects.

## Technical Tools Contain Protocols, Question Banks, Sample Letters, and More

---

These technical tools are intended to help state, local, Tribal, and territorial health departments conduct PFAS biomonitoring activities should they choose to (with the assumption that the principal source of PFAS exposure is from drinking water).

### These tools contain the following components:

- Biomonitoring sampling and analysis protocol
- Laboratory biomonitoring sample collection and analysis protocols
- Water sampling protocols
- Exposure and health effects question bank
- Biomonitoring letters of interpretation, consent, and assent
- Communication materials

### Biomonitoring Sampling and Analysis Protocol

This section provides a step-by-step approach to create a one-stage cluster sample of households for biomonitoring; calculate sample size using National Health and Nutrition Examination Survey (NHANES) national population PFAS estimates; and analyze data. The simple approach of one-stage cluster sampling was selected so that the biomonitoring results can be extrapolated to a local community.

### Exposure and Health Effects Question Bank

This section contain questions to create adult and child exposure assessment questionnaires. CDC/ATSDR designed the questions for current/long-term residents of a community where the primary suspected exposure source for PFAS is or was drinking water.

The adult questions collect information on demographics, pregnancy status and breastfeeding history for females, current drinking water habits, health conditions (see Appendix A), occupational history, and Alcohol and Tobacco use. The child questions additionally collect information on possible exposure at school/daycare. The bank also includes questions for other community-specific exposure pathways (e.g., gardening in contaminated soil, fishing in contaminated water bodies).

### Biomonitoring Letters of Interpretation, Consent, and Assent

This section contain customizable templates for interpretation letters, informed consents, and assent documents. The letter of interpretation is intended for participants who provided a blood sample for biomonitoring. It includes reference ranges for the U.S. population ages 12 or older based on results from the 2011–12 National Health and Nutrition Examination Survey (NHANES) and a customizable field for community results. Public health authorities should check for up-to-date NHANES data that could be used for result comparison (<https://www.cdc.gov/exposurereport/>). There is no reference data in NHANES for the 11 and younger age group; however, limited data may be available in the scientific literature (instructions included in the letter).

### Communications Materials

PFAS investigations to determine levels of risk or potential health effects can be complex and long-term rather than immediate. Health departments share the common challenge of explaining the limitations of the investigations, such as how much the science can actually show about the level of risk to a specific person, or to their concerned communities. Effective communication can be helpful. This section includes items such as fact sheets, frequently asked questions, audience outreach activities, and other materials to help inform the public about PFAS.

### **Laboratory Biomonitoring Sample Collection and Analysis Protocols**

This section contains the CDC PFAS laboratory manual/method and recommended serum collection procedures. The measurement methods are technically difficult and require special equipment not available in most clinical or hospital laboratories.

CDC is aware of several laboratories that measure PFAS, but does not endorse any specific laboratory. A list of these laboratories is available upon request. The list does not imply a CDC endorsement, and CDC may not be familiar with their operations or methods. In addition, the Association of Public Health Laboratories (APHL) may be able to identify state laboratories that can measure PFAS. Information about APHL is available at <https://www.aphl.org/Pages/default.aspx>.

### **Appendix A: List of Potential PFAS-associated health conditions**

This section provides the list of potential PFAS-associated health conditions or diseases based on the current scientific literature. The list may not be all-inclusive as most studies have examined small numbers of PFAS and many are cross-sectional studies. Investigators can use this list to create the health conditions section (Section C) based on concerns from their communities and the current scientific literature. Investigators can also consult a health care provider when developing the health conditions section.

### **Appendix B: Water Sampling Protocol**

For a water sampling protocol, visit the U.S. Environmental Protection Agency's (EPA) PFAS website (<https://www.epa.gov/water-research/epa-drinking-water-research-methods>). This website provides information on EPA's lab method recommended for water testing—method #537, titled "Determination of Selected Perfluorinated Alkyl Acids in Drinking Water by Solid Phase Extraction and Liquid Chromatography/Tandem Mass Spectrometry (LC/MS/MS)."

EPA's website also provides a technical advisory document, a general explanation, and questions and answers regarding the methodology. For assistance with analysis and interpretation of water testing results, please contact your local or state environmental health agencies or your regional EPA office (<https://www.epa.gov/aboutepa/visiting-regional-office>).

### **CDC/ATSDR Technical Assistance is Available**

---

CDC/ATSDR will provide technical assistance to health departments in developing and executing this biomonitoring and assessment approach. Please contact [pfas@cdc.gov](mailto:pfas@cdc.gov) if you would like to request assistance or if you have any questions or suggestions.



# PFAS Exposure Assessment in a Community: Sampling Strategy and Data Analysis Assistance

---

Per- and Polyfluoroalkyl Substance (PFAS) have been detected in numerous public and private drinking water supplies in the United States. Health departments may need help determining how to best assess exposure to PFAS. This document can help health departments conduct biomonitoring activities in communities with PFAS contamination in the drinking water supply.

## Consider Using a One-Stage Cluster Sample

---

A convenience sampling approach (i.e., a non-probability technique) is sometimes used for biomonitoring. However, this approach recruits participants that are not representative of the entire community's population, and the results from convenience samples cannot be used to extrapolate to the larger at-risk or exposed population in the community of concern.

A one-stage cluster sample, where the clusters are households and all individuals in each selected household are included in the sample, is a statistically-based, community sampling design that can be used to administer questionnaires and collect biomonitoring samples. It can also provide information about the range of PFAS exposures in an affected community. This sampling design is representative of the local population, allowing for inferences to be made on the entire sampling frame. This simple approach has been used by previous studies where PFAS exposure in communities was assessed and biomonitoring was performed [1, 2].

This document provides information on how to:

- Conduct a one-stage cluster sampling approach
- Estimate the sample size at the household level
- Analyze the data

This assistance assumes the biomonitoring activities are in a community with suspected or known current or recent PFAS contamination in the drinking water supply and sampling at household level.

## Step-by-Step Approach to One-Stage Cluster Sampling

---

### Step 1: Eligibility Criteria

Create the eligibility criteria, based on the known or suspected PFAS exposure in a specific geographical area and potential health concerns of the community. For example:

Individuals who are *{specify age limit if applicable}* currently living and had lived in the *{specify affected area (see step 2 below for examples)}* prior to *{insert date}*.

Eligibility criteria will likely vary by community. Knowledge of historical contamination and exposure is helpful in determining eligibility criteria.

### Step 2: Sampling Frame

Identify the geographic area where PFAS exposure is known or suspected. A one-stage cluster sample requires a complete list of all households in the geographic area of interest. This list will comprise the sampling frame.

## Sampling Strategy and Data Analysis Assistance

- a. If the geographic area is served by a potentially contaminated public water system, obtain a list of all households served by the public water system from the water company or local municipal water supply billing.
- b. If residents in the geographic area with potentially exposed groundwater receives water from private wells, obtain a list of households with private wells from the local health department.

Assign sequential numbers to each household on your list of households (1, 2, 3, ...N) (N is the total number of households in the geographic area). This is your sampling frame—the list from which you will draw the sample. You can also select multiple sampling frames based on known or suspected PFAS exposure (e.g., areas with high PFAS exposure and areas with low PFAS exposure). If you cannot obtain the sampling frame from water systems or for private wells, then use census information.

### Step 3: Select Households

Calculate the sample size (see section on sample size calculation below). Use a simple random number generator (such as <http://www.random.org/integers/>) to select the sample, using your list of households and sample size. For example, if your sample size is 94 households and your sampling frame contains 1,000 households, generate 94 random numbers between 1 and 1,000. Select the households corresponding to the 94 random numbers.

### Step 4: Select Individuals

Recruit all household members, including children, from selected households to participate in the study. Previous studies have used letters of participation, phone calls, or in-person visits to the households to recruit individuals. You can use a method that will fit your needs. Ask one individual from each household to identify all members currently living in the household.

### Step 5: Collect Information

Once you have recruited all individuals from a selected household,

- Administer consent and exposure assessment questionnaires (see Consent and Question Bank sections)
- Collect blood samples from every household member who provides consent and agrees to participate in the study (see Biomonitoring Sample Collection section).

For children under the age of 18, obtain assent from the child and consent from a parent or legal guardian (see example letters and forms in the Toolkit). A parent or legal guardian can also answer exposure assessment questionnaire for children.

You can administer biomonitoring sample collection and exposure assessment questionnaires at participants' houses or at a designated study site (based on your available resources). If you select the latter, be aware of potential human subjects' privacy issues: participants may be providing consent, blood samples, and questionnaire responses in a public setting (e.g., their identity is less confidential).

## Sample Size Calculation

Consider the following approach to estimate the required sample size. We selected a straightforward approach for simplicity in implementation.

Since the formula for a cluster sample requires an estimate of the within cluster correlation, we instead chose to use the formula for a simple random sample. The clustering is then accounted for only in an ad hoc way when obtaining the required sample size of households. First, estimate the required number of individuals. Then, account for the sampling design to obtain the required sample size of households. To normalize the distribution, we recommend using  $\ln(\text{values})$ . This is because lab values are typically positive and have distributions that are skewed rather than symmetric. We assume the PFAS values will also have a lognormal distribution. In the following,  $\ln(\ )$  refers to the natural logarithm (base e, not base 10).

$n$  = sample size of households  
 $m$  = sample size of individuals  
 $\alpha$  = level of significance  
 $E$  = maximum error  
 $\sigma$  = standard deviation of the logarithm of measured PFAS levels

The required sample size of individuals is given by:

$$m = \left[ \frac{Z_{\alpha/2} * \sigma}{E} \right]^2$$

An example using National Health and Nutrition Examination Survey (NHANES) data is completely worked out below, but you should use local data on serum PFAS levels of the affected community, if available. However, if preliminary local data on PFAS exposure is not available, then use national data to help estimate sample size. For the example below, we used national data from 2013–2014 NHANES. The geometric mean for serum PFOS was 4.99  $\mu\text{g/L}$  for the US population in 2013–2014. The corresponding 95% confidence interval (4.50, 5.52) and the NHANES [3] sample size of 2,165 are used to estimate  $\sigma$ , the standard deviation of the  $\ln(\text{values})$ .

Specifically, one approach is to use the formula for the 95% upper confidence limit (UCL) of the geometric mean (GM), and solve for  $\sigma$ :

$$\begin{aligned} \hat{\sigma} &= \frac{\sqrt{n} * [\ln(UCL) - \ln(GM)]}{Z_{\alpha/2}} \\ &= \frac{\sqrt{2165} * [\ln(5.52) - \ln(4.99)]}{1.96} = 2.40 \end{aligned}$$

The sample size of individuals to estimate the mean with maximum error  $E = 15\%$  of the  $\ln(GM)$  at the 5% level of significance is:

$$m = \left[ \frac{1.96 * \hat{\sigma}}{0.15 * \ln(GM)} \right]^2$$

Using the values from NHANES, the sample size of individuals is:

$$m = \left[ \frac{1.96 * 2.40}{0.15 * \ln(4.99)} \right]^2 = 379$$

For simplicity, we chose to set the maximum error as a percent of the  $\ln(\text{GM})$ . 15% was chosen for the illustration because a maximum error of within 15% of the  $\ln(\text{GM})$  was a reasonable choice. Many other choices are reasonable and may be preferable, depending on circumstances. If maximum error is set to 10 or 20 percent of  $\ln(\text{GM})$ , then the sample size of individuals  $m$  is 854 or 213, respectively.

Recall that  $N$  = the total number of households in the geographic area. Let  $M$  = the total number of individuals in the geographic area. The average household size in the geographic area is  $M/N$ . So, accounting for the survey design (including all individuals from each selected household in the sample), the required sample size of households is given by  $n = m * (N/M)$ .

For example, if  $m = 379$ ,  $N = 1,000$ ,  $M = 2,500$ ,  $\alpha = 0.05$ , and  $E = 0.15 * \ln(4.99)$ , then a sample of  $n = 152$  households is needed.

Adjust this sample size estimate to ensure adequate precision despite non-participating households (see section on Participation Bias below). For example, if a response rate of 65% is expected, then use  $n = 152/0.65 = 233$ .

**This example is only for illustrating the use of the formulas and not a recommendation of 233 as the required sample size in any particular situation.**

Once you determine the geographic boundaries, you can find the population total ( $M$ ) for the area by using U.S. Census Bureau data (see <https://factfinder.census.gov/faces/nav/jsf/pages/searchresults.xhtml?refresh=t>).

## Data Analysis

This section suggests data analysis to estimate community-based PFAS exposure level. We recommend using the geometric mean to minimize the effect of very high or low values. A highly skewed distribution is common in the measurement of environmental chemicals in blood. In instances where the biomonitoring data are highly skewed, geometric means are often used.

The geometric mean is the exponentiated value of the mean of the log-transformed measured values. The geometric mean is influenced less by high values than is the arithmetic mean. Information on estimating the geometric mean and its associated confidence interval that account for the one-stage cluster design is provided below. However, if results are normally distributed, then base the analysis on the mean rather than the geometric mean.

### Estimate the Geometric Mean

Let  $n$  be the number of households in the sample, and  $m_i$  be the number of individuals in the  $i^{\text{th}}$  household of the sample. Let  $y_{ij}$  be the measured value of the PFAS of interest for the  $j^{\text{th}}$  individual in the  $i^{\text{th}}$  household. Then, estimate the geometric mean (GM) as:

$$\widehat{GM} = \exp \left[ \frac{\sum_{i=1}^n \sum_{j=1}^{m_i} \ln(y_{ij})}{\sum_{i=1}^n m_i} \right]$$

So, an estimate of the geometric mean is simply obtained by finding the overall mean of the  $\ln(\text{values})$  in the sample and taking the exponentiation of that result. The  $m_i$  serve as weights accounting for household size. If any of the  $y_{ij}$  are below the limit of detection (LOD), then substitute  $\text{LOD}/\sqrt{2}$ .

### Confidence Interval for the Geometric Mean

Let  $N$  be the total number of households and  $M$  be the total number of individuals in the sampling frame. Let  $f = n/N$  be the sampling fraction. Let  $\bar{a}_i$  and  $\bar{a}$  be the mean for household  $i$  and the overall mean of the  $\ln(\text{values})$  in the sample, respectively.

$$\bar{a}_i = \frac{1}{m_i} \sum_{j=1}^{m_i} \ln(y_{ij})$$

$$\bar{a} = \frac{\sum_{i=1}^n \sum_{j=1}^{m_i} \ln(y_{ij})}{\sum_{i=1}^n m_i}$$

Use the variance for a ratio estimator because  $\bar{a}$  is a ratio estimator for a one-stage cluster design. Estimate the variance of  $\ln(\text{GM})$  by:

$$\widehat{\text{Var}}[\ln(\text{GM})] = \frac{N^2(1-f)}{M^2n(n-1)} \sum_{i=1}^n m_i^2 (\bar{a}_i - \bar{a})^2$$

Then, a 95% confidence interval for the geometric mean is given by:

$$\exp \left[ \bar{a} \pm 1.96 \sqrt{\widehat{\text{Var}}[\ln(\text{GM})]} \right]$$

### Stratification

When you need separate estimates for high and low exposure areas (or for more categories of exposure), then add an extra stage (stratification) of sampling to the design. You can use this to recruit individuals of interest for one or more strata.

Estimate separate sample sizes for each stratum, then use stratum PFAS estimates to calculate the overall community PFAS estimate. You will also need stratum specific weights to calculate the overall PFAS estimates of the community [4]. Use the description above (Data Analysis) for stratum-specific estimates for each geometric mean and confidence interval calculations.

A description of how to combine the stratum-specific estimates to obtain the overall community PFAS estimate is below:

- Let  $L$  be the total number of strata and  $m_{ih}$  be the number of individuals in the  $i^{\text{th}}$  household of the  $h^{\text{th}}$  stratum.
- Let  $y_{ijh}$  be the measured value of the PFAS of interest for the  $j^{\text{th}}$  individual in the  $i^{\text{th}}$  household of the  $h^{\text{th}}$  stratum.
- Divide the sampling frame into  $L$  strata containing  $N_1, N_2, \dots, N_L$  households, respectively.

The stratum specific weight is  $N_h/N$  for the  $h^{\text{th}}$  stratum. The sample sizes within the strata are denoted  $n_1, n_2, \dots, n_L$ , respectively. Let  $\bar{a}_{ih}$  and  $\bar{a}_h$  be the mean for household  $i$  and the overall mean of the  $\ln(\text{values})$  in  $h^{\text{th}}$  stratum, respectively. Specifically:

$$\bar{a}_{ih} = \frac{1}{m_{ih}} \sum_{j=1}^{m_{ih}} \ln(y_{ijh})$$

$$\bar{a}_h = \frac{\sum_{i=1}^{n_h} \sum_{j=1}^{m_{ih}} \ln(y_{ijh})}{\sum_{i=1}^{n_h} m_{ih}}$$

Then, estimate the overall geometric mean as:

$$\widehat{GM} = \exp \left[ \frac{\sum_{h=1}^L N_h \bar{a}_h}{N} \right]$$

Estimate the variance of  $\ln(GM)_h$  for stratum h by:

$$\widehat{Var}[\ln(GM)_h] = \frac{N_h^2(1-f_h)}{M_h^2 n_h(n_h-1)} \sum_{i=1}^{n_h} m_{ih}^2 (\bar{a}_{ih} - \bar{a}_h)^2$$

Then, estimate the variance of the overall  $\ln(GM)$  by:

$$\widehat{Var}[\ln(GM)] = \exp \left[ \frac{\sum_{h=1}^L N_h^2 \widehat{Var}[\ln(GM)_h]}{N^2} \right]$$

Then, a 95% confidence interval for the overall geometric mean is given by:

$$\exp \left[ \frac{\sum_{h=1}^L N_h \bar{a}_h}{N} \pm 1.96 \sqrt{\widehat{Var}[\ln(GM)]} \right]$$

You can use a statistical analysis package such as SAS to account for the one-stage cluster design and stratification. You can use SAS or other statistical analysis package to estimate the geometric mean and obtain its confidence interval, as well as to obtain univariate and multivariate analyses for all questionnaire and other survey data.

## Participation Bias

It may not be possible to get household or individual participation, even after multiple contact attempts. Since those that do not choose to participate may be substantively different from those that do, you may have participation bias. However, all sampling designs are susceptible to participation bias. Do not replace households that choose not to participate. This would increase the level of potential participation bias. However, it is appropriate to replace households that do not meet the eligibility criteria.

A low participation rate will also result in less precision in sample estimates. Inflate the required sample size to ensure adequate precision (see section on Sample Size Calculation above).

## Data Analysis

Using a statistical package that includes a sample survey procedure (e.g., SAS® software) can improve accuracy for calculating the geometric mean and confidence intervals. If needed, the statistical package should include an algorithm that accounts for a one-stage cluster design and a second stage for stratification. For example, in SAS, you can perform PROC GEOMEAN to estimate the geometric mean and its confidence interval. PROC GEOMEAN

accounts for the survey design and enables a univariate analysis. You can also use the statistical package to perform univariate or multivariate analyses on the questionnaire data.

### Estimate the Geometric Mean to Estimate PFAS Levels of a Community

The following example demonstrates how to calculate the geometric mean and confidence interval using the formulas provided above. The sample size in the example is just  $n=4$  households (HH). The table shows the number of individuals in each HH ( $m$ ) and measured PFAS level ( $y$ ) in blood samples of household members in each HH:

HH	Number of individuals in HH	PFAS levels of household members ( $\mu\text{g/L}$ )					
		<i>Member 1</i>	<i>Member 2</i>	<i>Member 3</i>	<i>Member 4</i>	<i>Member 5</i>	<i>Member 6</i>
HH1	1	5					
HH2	2	<LOD*	12				
HH3	4	4	5	5	6		
HH4	6	4	5	6	6	8	20

\*LOD = 3  $\mu\text{g/L}$ ; For PFAS level <LOD, then substitute LOD/2

Using the formula for geometric mean above,

$$\sum_{i=1}^n \sum_{j=1}^{m_i} \ln(y_{ij}) = \ln(5) + \ln(3/\sqrt{2}) + \ln(12) + \ln(4) + \dots + \ln(8) + \ln(20) = 22.8977$$

$$\sum_{i=1}^n m_i = 1 + 2 + 4 + 6 = 13$$

$$\widehat{GM} = \exp\left[\frac{22.8977}{13}\right] = 5.82 \mu\text{g/L}$$

The geometric mean of all household members from four households is 5.82  $\mu\text{g/L}$ .

### Confidence Interval for the Geometric Mean

Using the formula for confidence interval listed above, where  $\bar{a}_i$  and  $\bar{a}$  are the mean for  $i^{\text{th}}$  household and the overall mean of the  $\ln(\text{values})$  in the sample, respectively,

$$\bar{a}_1 = \frac{1}{1} (\ln(5)) = 1.60944$$

$$\bar{a}_2 = \frac{1}{2} (\ln(3/\sqrt{2}) + \ln(12)) = 1.61847$$

$$\bar{a}_3 = \frac{1}{4} (\ln(4) + \ln(5) + \ln(5) + \ln(6)) = 1.59923$$

$$\bar{a}_4 = \frac{1}{6} (\ln(4) + \ln(5) + \ln(6) + \ln(6) + \ln(8) + \ln(20)) = 1.94240$$

$$\bar{a} = \frac{22.8977}{13} = 1.76136$$

$$\sum_{i=1}^n m_i^2 (\bar{a}_i - \bar{a})^2 = 1^2 * (1.60944-1.76136)^2 + 2^2 * (1.61847-1.76136)^2 + 4^2 * (1.59923-1.76136)^2 + 6^2 * (1.94240-1.76136)^2 = 1.70525$$

Suppose that total number of households (N) = 1,000 and the total number of individuals (M) = 2,500, then variance of ln(GM) is:

$$\widehat{Var}[\ln(GM)] = \frac{1000^2(1 - 4/1000)}{2500^2 4(4-1)} * 1.70525 = \mathbf{0.022646}$$

A 95% confidence interval (CI) for the geometric mean is:

$$\exp[1.76136 \pm 1.96\sqrt{0.022646}] = \mathbf{(4.33, 7.82)}$$

Therefore, for a sample size of four households, we calculated the geometric mean of measured PFAS level of the community as 5.82 µg/L (95% CI= 4.33 µg/L, 7.82 µg/L).



## References

1. Emmett, EA, et al., *Community Exposure to Perfluorooctanoate: Relationships Between Serum Concentrations and Exposure Sources*. *Journal of occupational and environmental medicine / American College of Occupational and Environmental Medicine*, 2006. 48(8): 759-770.
2. Emmett, EA, et al., *Community Exposure to Perfluorooctanoate: Relationships Between Serum Levels and Certain Health Parameters*. *Journal of occupational and environmental medicine / American College of Occupational and Environmental Medicine*, 2006. 48(8): 771-779.
3. Centers for Disease Control and Prevention (CDC). National Center for Health Statistics (NCHS). *National Health and Nutrition Examination Survey Data (NHANES). Updated Tables*. 2015, U.S. Department of Health and Human Services, Centers for Disease Control and Prevention: Hyattsville, MD.
4. Cochran, WG. *Sampling Techniques*, 3<sup>rd</sup> Edition. 1977. John Wiley & Sons. NY (pp 89-92).

## PFAS Exposure Assessment Question Bank: Adults

---

This document provides a set of questions for state or local health departments to create a questionnaire for a Per- and Polyfluoroalkyl Substances (PFAS) exposure assessment of adults. Users can choose the type and order of questions from different sections listed below to create the questionnaire.

The question bank contains four sections:

- **Section A: Demographic Information**
- **Section B: Exposure Assessment**
- **Section C: Health Conditions**
- **Section D: Occupational History**

Each section has questions that are adapted from CDC's National Health and Nutrition Examination Survey (NHANES) and several other questionnaires used by state and local health departments for PFAS exposure assessments. State or local health departments can use this question bank to design questionnaires tailored to their communities' needs to assess PFAS exposures.

**Section A: Demographic Information**

**This section provides sample questions to collect demographic information, as well as pregnancy and breastfeeding history information.**

1. Unique ID: \_\_\_\_\_
2. What is your name (Last, First, Middle Initial): \_\_\_\_\_
3. What is your date of birth (MM/DD/YYYY): \_\_/\_\_/\_\_\_\_  Don't know  Refused to answer
4. What is your sex:  Male  Female  Other  Refused to answer
5. What is your height: \_\_\_\_ (Feet) \_\_\_\_ (Inches)  Don't know  Refused to answer
6. What is your weight: \_\_\_\_ (Pounds)  Don't know  Refused to answer
7. What is your address?  
Street \_\_\_\_\_ City \_\_\_\_\_ State \_\_ Zip \_\_\_\_\_  Refused to answer
8. What is the best phone number to reach you? Please specify if this is a cellular phone, house phone, or work phone.  
(\_\_\_\_) \_\_\_\_ - \_\_\_\_  Cell  House  Work  Refused to answer
9. What is your email address?  
\_\_\_\_\_  Don't know  Refused to answer  Not Applicable
10. Do you consider yourself to be Hispanic, Latino, or of Spanish origin?  
 Yes  No  Don't know  Refused to answer
11. Which one or more of the following would you say is your race? (Select all that apply)  
 American Indian or Alaska Native  Asian  Black or African American  
 Native Hawaiian or Other Pacific Islander  White  Don't know  
 Refused to answer

**Questions 12 to 17 are for Adult FEMALES ONLY.**

12. Are you currently pregnant?  
 Yes  No  Don't know  Refused to answer  Not Applicable
13. Have you been pregnant in the past from {add number of years of interest}?  
 Yes  No  Don't know  Refused to answer  Not Applicable
14. If yes, please provide the number of pregnancies:  
\_\_\_\_ (number)  Don't know  Refused to answer  Not Applicable
15. For each pregnancy, please provide the following information:

Number	Did this pregnancy result in live birth?(Y/N)	If yes, provide delivery date (MM/DD/YYYY):	Was child breastfed? (Y/N)	If yes, provide duration of breastfeeding (in months)

Question Bank: Adults

16. Have you completed menopause?  
 Yes  No  Currently going through menopause  Don't know  
 Refused to answer  Not Applicable
17. If yes, how old were you when completed menopause?  
\_\_\_ (years)  Don't know  Refused to answer  Not Applicable
18. What is your annual household income?  
 Less than \$15,000  \$15,000 to less than \$25,000  
 \$25,000 to less than \$35,000  \$35,000 to less than \$50,000  
 \$50,000 to less than \$75,000  \$75,000 or more  
 Don't know  Refused to answer
19. What is the highest grade or year of school you completed?  
 Never attended school  Grades 1 through 8 (Elementary)  
 Grade 9 through 11 (Some high school)  Grade 12 or GED (High school graduate)  
 Some college or technical school  College 4 years or more  
 Don't know  Refused to answer



Question Bank: Adults

- Other, specify: \_\_\_\_\_  Don't Know
- Refused to answer  Not Applicable

**Questions 8 through 12 are referring to the locations in the affected area/sampling frame only (show map or list of location if applicable). These questions can be used if the exposure assessment includes exposures other than or in addition to drinking water.**

If area soil may be contaminated from past air contamination deposition from a nearby manufacturer, or by watering lawns, gardens, crops with contaminated water consider these potential exposure sources.

8. How frequently do you work or play in the soil (e.g. gardening, digging, farming, building, repairing, etc.) in *{insert affected area/sampling frame/locations}*? (Select one)
- Once per month  A few times per year  Once per year
- Rarely  Never  Don't know
- Refused to answer

9. If you work in the soil, at what address or place does this occur (list all locations)?

---

---

- Refused to answer  Not Applicable

10. How often do you eat "homegrown" or locally grown vegetables from *{insert affected area/sampling frame/locations}*? (Select one)
- Several times per month  Few times per month  Once per month
- A few times per year  Once per year  Rarely
- Never  Don't know  Refused to answer

If area surface water bodies are contaminated and local fishing is possible:

11. How often do you eat fish locally caught from ponds, lakes, or rivers in *{insert affected area/sampling frame/locations}*? (Select one)
- Several times per month  Few times per month  Once per month
- A few times per year  Once per year  Rarely
- Never  Don't know  Refused to answer

If livestock are raised in areas with soil contamination or if their drinking water source was contaminated:

12. How often you consume milk from animals raised on farms within *{insert sampling/affected area/location or list of affected farms}*?
- Several times per month  Few times per month  Once per month
- A few times per year  Once per year  Rarely
- Never  Don't know  Refused to answer

13. Have you ever donated blood?

Question Bank: Adults

- Yes  No (**If selected, SKIP questions 14 and 15**)  Don't know  Refused to answer  
 Not Applicable

14. When did you last donated blood?

- \_\_ (months) \_\_\_\_ (year)  Don't know  Refused to answer  Not Applicable

15. On average, how often do you donate blood in a year?

- \_\_\_\_\_  Don't know  Refused to answer  Not Applicable

16. Have you ever had a blood transfusion?

- Yes  No (**If selected, SKIP question 17**)  Don't know  Refused to answer  
 Not Applicable

17. When did you last have a blood transfusion?

- \_\_ (months) \_\_\_\_ (year)  Don't know  Refused to answer  Not Applicable

## Section C: Health Conditions

This section provides sample question to collect information related to past and/or existing health conditions or diseases. Investigators can create an open-ended question to collect information on past and/or existing health condition or diseases by organ system or they create a list of specific health effects based on their community concerns or past research. A list of potential PFAS-associated adverse health conditions or diseases studied in the existing literature is also provided in Appendix A.

1. Please provide information about all health conditions or disease you were diagnosed with in the *{add number of years of interest}* by your doctor:

<b>Organ System</b>	<b>Condition (add additional rows as needed)</b>	<b>Year diagnosed</b>
Cardiovascular	<i>{Health condition or disease}</i>	
Endocrine (hormonal)	<i>{Health condition or disease}</i>	
Gastrointestinal	<i>{Health condition or disease}</i>	
Integumentary (dermal)	<i>{Health condition or disease}</i>	
Lymphatic	<i>{Health condition or disease}</i>	
Muscular	<i>{Health condition or disease}</i>	
Neurologic	<i>{Health condition or disease}</i>	
Reproductive	<i>{Health condition or disease}</i>	
Skeletal	<i>{Health condition or disease}</i>	
Urinary	<i>{Health condition or disease}</i>	
Other	<i>{Health condition or disease}</i>	



## Section D: Occupational History

This section provides sample questions to collect information about participant's occupational history.

1. Have you been employed in the last 20 years?  
 Yes    No (**If selected, SKIP this section**)    Don't know    Refused to answer
2. Is your current or past workplace in {*add number of years of interest*} located in the {*specify affected area or area of interest*}? (Use of a map to help identify if school/daycare located in the affected area or area of interest)  
 Yes    No    Don't know    Refused to answer
3. How long have you worked at your current/previous {*add duration based on exposure e.g., 1 yr or 5 yr etc.*} workplace present in {*add affected/selected area here*}?  
 \_\_\_ (months)   \_\_\_ (years)    Don't know    Refused to answer
4. What is/was the main source of drinking water you used at your workplace? (Select **one**)
  - Public water system (City or County)   Provide name: \_\_\_\_\_
  - Private Well    Community well
  - Bottled Water    Don't Know
  - Refused to answer
5. During the time you worked at a workplace served by the {*name of water system/private/community well*}, on average how many 8 oz cups of water or beverages prepared with tap water did you drink per day?  
 \_\_\_ (8 oz cups)    Didn't drink tap water    Don't know    Refused to answer  
**Note:** 1 cup = 8 oz; 2 cups = 1 pint (16 oz); 4 cups = 1 quart (32 oz); 16 cups = 1 Gallon (128 oz)

**NOTE: Due to their unique physical and chemical properties, PFAS are used in a variety of industrial applications and consumer products. PFAS have been used to provide non-stick surfaces on cookware and waterproof coatings for textiles and paper products. They serve as high performance surfactants in numerous products that must flow freely, including paints, cleaning products, fire-fighting foams used to fight fuel-based fires, and engineering coatings used in semiconductor production [1].**

**Beyond these uses, PFAS have been employed in hundreds of other applications across almost all industrial sectors, some of which are highlighted in Table 1. This questionnaire is not meant to be a comprehensive list of questions about all possible and relevant PFAS exposure sources. Environmental and occupational exposures can differ greatly among communities and public health officials choosing to conduct PFAS biomonitoring activities may need to consider adding questions regarding other sources of possible PFAS exposure.**

6. Did you in the last {*add duration based on exposure e.g., 1 yr or 5 yr*} work at any of the following industries?
  - Manufacturing of nonstick cookware such as Teflon® coated pots/pans
  - Manufacturing of stain resistant coatings (e.g. Scotchguard®) used on carpets, upholstery, and other fabrics
  - Manufacturing of water resistant clothing (e.g. Gore-Tex®)

Question Bank: Adults

Never worked in the industries listed above

7. Were/Are you a firefighter {add duration based on exposure e.g., 1 yr or 5 yr etc.}? Yes No  
 Don't know  Refused to answer

8. If you worked in any of the industries listed in question 6 (also see Table 1 for detail list of industries) or was/is a firefighter, please provide your job title, brief job description, and duration of your work.

Company Name	Job Title	Brief Job Description	Year Started	Year Ended

**Table 1. Common Uses of PFAS**

Consumer Products	Industrial Uses
Cookware (Teflon <sup>®</sup> , Nonstick)	Photo-Imaging
Fast Food Containers	Metal Plating
Candy Wrappers	Semiconductor Coatings
Microwave Popcorn Bags	Aviation Hydraulic Fluids
Personal Care Products (Shampoo, Dental Floss)	Medical Devices
Cosmetics (Nail Polish, Eye Makeup)	Fire-Fighting Foam
Paints and Varnishes	Insect Baits
Stain Resistant Carpet	Printer and Copy Machine Parts
Stain Resistant Chemicals (Scotchguard <sup>®</sup> )	Chemically Driven Oil Production
Water Resistant Apparel (Gore-Tex <sup>®</sup> )	Textiles, Upholstery, Apparel and Carpets
Cleaning Products	Paper and Packaging
Electronics	Rubber and Plastics

## Section E: Alcohol and Tobacco Use

This section provides sample questions to assess alcohol and tobacco use.

The following questions ask about alcohol use. This includes beer, wine, wine coolers, and liquor such as rum, gin, vodka, or whiskey. This does not include drinking a few sips of wine for religious purposes.

- How old were you when you had your **first** drink of alcohol, other than few sips?
  - I have never had a drink of alcohol other than a few sips (**If selected SKIP questions 2 and 3**)
  - 8 years old or younger       9 to 17 years old       18 years old or older
  - Don't know       Refused to answer
- During your **entire life**, on how many days you had at least one drink of alcohol?
  - 1 or 2 days       3 to 9 days       10 to 19 days
  - 20 to 39 days       40 to 99 days       100 or more days
  - Don't know       Refused to answer       Not applicable
- During the past **30 days**, on how many days did you have at least one drink of alcohol?
  - 0 days       1 or 2 days       3 to 5 days
  - 6 to 9 days       10 to 19 days       20 to 29 days
  - All 30 days       Don't know       Refused to answer
  - Not applicable

The following questions are about cigarette smoking and other tobacco use. Do **not** include marijuana.

- How old were you when you smoked a whole cigarette for the first time?
  - I have never smoked, not even a puff (**If selected SKIP questions 2 to 6**)
  - 8 years old or younger       9 to 17 years old       18 years old or older
  - Don't know       Refused to answer
- About how many cigarettes have you smoked in your **entire life**?
  - 1 or more puffs but never a whole cigarette
  - 1 cigarette       2 to 5 cigarettes       6 to 15 cigarettes
  - 16 to 25 cigarettes       26 to 99 cigarettes       100 or more cigarettes
  - Don't know       Refused to answer       Not applicable
- During the past **30 days**, on how many days did you smoke cigarettes?
  - 0 days       1 or 2 days       3 to 5 days
  - 6 to 9 days       10 to 19 days       20 to 29 days
  - All 30 days       Don't know       Refused to answer
  - Not applicable
- During the past **30 days**, on the days you smoked, how many cigarettes did you smoke per day?
  - 1 or more puffs but never a whole cigarette
  - 1 cigarette       2 to 5 cigarettes       6 to 15 cigarettes
  - 16 to 25 cigarettes       26 to 99 cigarettes       100 or more cigarettes
  - Don't know       Refused to answer       Not applicable
- How long has it been since you quit smoking cigarettes?
  - I am currently a smoker       1 or 6 days       1 to 4 weeks
  - 1 to 12 months       1 to 5 years       6 to 10 years
  - 11 or more years       Don't know       Refused to answer
  - Not applicable
- How old were you when you last smoked cigarettes?
  - Don't know       Refused to answer       Not applicable

Question Bank: Adults

The following questions ask about use of tobacco products.

7. Did you smoke pipes, cigars, little cigars or cigarillos, water pipes, hookahs, or e-cigarettes in your **entire life**?  
 Yes     No (If selected SKIP question 8 to 10)     Don't know     Refused to answer
8. Which of these products did you smoke? (Select all that apply)  
 Pipes                                       Cigars                                       little cigars or cigarillo  
 Water pipes or Hookahs               E-cigarettes                               Don't know  
 Refused to answer
9. During the past **30 days**, on how many days did you smoke *{specify tobacco product selected in Q8}*?  
(NOTE: repeat this question for each selected tobacco product selected in questions 8)  
 0 days                                       1 or 2 days                                       3 to 5 days  
 6 to 9 days                                       10 to 19 days                                       20 to 29 days  
 All 30 days                                       Don't know                                       Refused to answer  
 Not applicable
10. During the past **30 days**, on the days you smoked, how many of *{specify tobacco product selected in Q8}* did you smoke per day? (NOTE: repeat this question for each selected tobacco product selected in questions 8)  
 1 or more puffs but never a whole cigarette  
 1 cigarette                                       2 to 5 cigarettes                                       6 to 15 cigarettes  
 16 to 25 cigarettes                                       26 to 99 cigarettes                                       100 or more cigarettes  
 Don't know                                       Refused to answer                                       Not applicable

## PFAS Exposure Assessment Question Bank: Child

---

**This document provides a set of questions for state or local health departments to create a questionnaire for a Per- and Polyfluoroalkyl Substances (PFAS) exposure assessment of children. Users can choose the type and order of questions from different sections listed below to create the questionnaire.**

The question bank contains four sections:

- **Section A: Demographic Information**
- **Section B: Exposure Assessment**
- **Section C: Health Conditions**

Each section has questions that are adapted from the National Health and Nutrition Examination Survey (NHANES) and several other questionnaires used by state and local health departments for PFAS exposure assessments. State or local health department can use this question bank to design questionnaires tailored to their communities' needs to assess PFAS exposures.

**If a child is under the age of 16, a parent or legal guardian can answer all questions listed in this question bank.**

## Section A: Demographic Information

This section provides sample question to collect demographic information.

1. Unique ID: \_\_\_\_\_
2. What is your child's name (Last, First, Middle Initial): \_\_\_\_\_
3. What is your child's date of birth (MM/DD/YYYY): \_\_\_ / \_\_\_ / \_\_\_\_  Don't know  Refused to answer
4. What is your child's sex:  Male  Female  Refused to answer
5. What is your child's height: \_\_\_ (Feet) \_\_\_ (Inches) **or** \_\_\_ (cm)  Don't know  Refused to answer
6. What is your child's weight: \_\_\_\_\_ (Pounds) **or** \_\_\_\_\_ (kg)  Don't know  Refused to answer
7. What is your child's birth order (e.g. first, second, or third born etc.)?  
\_\_\_\_\_  Don't know  Refused to answer
8. What is the address where your child lives with you?  
Street \_\_\_\_\_ City \_\_\_\_\_ State \_\_\_ Zip \_\_\_\_\_  Refused to answer
9. Please provide mailing address for your child. (If different from #7)  
Street \_\_\_\_\_ City \_\_\_\_\_ State \_\_\_ Zip \_\_\_\_\_  Refused to answer
10. Do you consider your child to be Hispanic, Latino, or of Spanish origin?  
 Yes  No  Don't know  Refused to answer
11. Which one or more of the following would you say is your child's race? (Select all that apply)  
 American Indian or Alaska Native  Asian  Black or African American  
 Native Hawaiian or Other Pacific Islander  White  Don't know  
 Refused to answer
12. What is the grade level of education your child has completed?  
\_\_\_ (grade)  Don't know  Refused to answer  Not applicable



9. Which water filter or treatment device(s) are you currently using to filter or treat the tap water you drink? (Select all that apply)

- |   |   |
|---|---|
| <input type="checkbox"/> None, no filter or treatment device used | <input type="checkbox"/> None, use bottled water only |
| <input type="checkbox"/> Whole house carbon filter                | <input type="checkbox"/> Under the sink carbon filter |
| <input type="checkbox"/> Kitchen faucet filter                    | <input type="checkbox"/> Pitcher filter               |
| <input type="checkbox"/> Reverse osmosis (RO) system              | <input type="checkbox"/> Other, specify: _____        |
| <input type="checkbox"/> Don't Know                               | <input type="checkbox"/> Refused to answer            |
|   | <input type="checkbox"/> Not Applicable               |

**Questions 10 through 14 are referring to the locations in the affected area/sampling frame only (show map or list of location if applicable). These questions can be used if the exposure assessment includes exposures other than or in addition to drinking water.**

10. How frequently does your child play in the soil in *{insert affected area/sampling frame/locations}*? (Select one)

- |  |  |  |
|--|--|--|
| <input type="checkbox"/> Several times per month | <input type="checkbox"/> Few times per month | <input type="checkbox"/> Once per month    |
| <input type="checkbox"/> A few times per year    | <input type="checkbox"/> Once per year       | <input type="checkbox"/> Rarely            |
| <input type="checkbox"/> Never                   | <input type="checkbox"/> Don't know          | <input type="checkbox"/> Refused to answer |

11. If your child plays in the soil, at what address or place (e.g. daycare) does this occur (list all locations):

---



---

- Don't know    Refused to answer    Not Applicable

12. How often does your child eat "homegrown" or locally grown vegetables from *{insert affected area/sampling frame/locations}*? (Select one)

- |  |  |  |
|--|--|--|
| <input type="checkbox"/> Several times per month | <input type="checkbox"/> Few times per month | <input type="checkbox"/> Once per month    |
| <input type="checkbox"/> A few times per year    | <input type="checkbox"/> Once per year       | <input type="checkbox"/> Rarely            |
| <input type="checkbox"/> Never                   | <input type="checkbox"/> Don't know          | <input type="checkbox"/> Refused to answer |

13. How often does your child eat fish locally caught from ponds, lakes or rivers in *{insert affected area/sampling frame/locations}*? (Select one)

- |  |  |  |
|--|--|--|
| <input type="checkbox"/> Several times per month | <input type="checkbox"/> Few times per month | <input type="checkbox"/> Once per month    |
| <input type="checkbox"/> A few times per year    | <input type="checkbox"/> Once per year       | <input type="checkbox"/> Rarely            |
| <input type="checkbox"/> Never                   | <input type="checkbox"/> Don't know          | <input type="checkbox"/> Refused to answer |

14. How often does your child consume milk from animals raised on farms within *{insert sampling/affected area/location or list of affected farms}*?

- |  |  |  |
|--|--|--|
| <input type="checkbox"/> Several times per month | <input type="checkbox"/> Few times per month | <input type="checkbox"/> Once per month    |
| <input type="checkbox"/> A few times per year    | <input type="checkbox"/> Once per year       | <input type="checkbox"/> Rarely            |
| <input type="checkbox"/> Never                   | <input type="checkbox"/> Don't know          | <input type="checkbox"/> Refused to answer |



Question Bank: Child

15. Does your child breastfeed currently?  
 Yes  No  Don't know  Refused to answer  Not Applicable
16. Did your child breastfeed previously?  
 Yes  No  Don't know  Refused to answer  Not Applicable
17. At what age did your child stop breastfeeding (*example 2 years 0 months*)?  
 \_\_ (years) \_\_ (months)  Don't know  Refused to answer  Not Applicable
18. Does your child drink formula currently?  
 Yes  No  Don't know  Refused to answer  Not Applicable
19. Did your child drink formula previously?  
 Yes  No  Don't know  Refused to answer  Not Applicable
20. If yes, how much formula does your child take in a day? \_\_\_ oz
21. At what age did you child stop drinking formula (*example 2 years 0 months*)?  
 \_\_ (years) \_\_ (months)  Don't know  Refused to answer  Not Applicable
22. Did you use tap water, which you use as the primary drinking water source, to make the formula?  Yes  
 No  Don't know  Refused to answer  Not Applicable

**Questions 23 to 26 are regarding your child's school or daycare located in the affected area/sampling frame. If your child did not go to a school or daycare in the last 8 years located in the affected area/sampling frame, SKIP to the next section.**

23. Is your child currently attending or in the last {*add number of years of interest*} attended, a school or daycare?  
 Yes  No  Don't know  Refused to answer  Not Applicable

24. Please provide the name of your child's school or daycare and duration they attended each school/daycare? (Use of a map to help identify if school/daycare located in the affected area or area of interest)

Name of School/Daycare	Address	Duration Attended		Located in Affected area	
		Start Year	End Year	Yes	No

**Note: Use #25 for every school/daycare listed in #24 that is/was present in the affected area of interest.**

Question Bank: Child

25. What is/was your child's main source of drinking water in school or daycare {insert name from listed in #22}? (Select **one**)

- Public water system of school or daycare (City or County) Provide name: \_\_\_\_\_
- Private Well
- Pond
- Community well
- Water brought from home
- Refused to answer
- Spring
- Cistern
- Bottled Water
- Don't Know

26. During the time your child stayed at the daycare or school served by the {*name of water system/private/community well*}, how many 8 oz cups of water or beverages prepared with tap water did your child drink per day?

\_\_\_\_\_  Didn't drink tap water     Don't know     Refused to answer

Note: 1 cup = 8 oz; 2 cups = 1 pint (16 oz); 4 cups = 1 quart (32 oz); 16 cups = 1 Gallon (128 oz)

## Section C: Health Conditions

This section provides sample question to collect information related to past and/or existing health conditions or diseases. Investigator can create an open-ended question to collect information on past and/or existing health condition or diseases by organ system or they create a list of specific health effects based on their community concerns or past research. A list of potential PFAS-associated adverse health conditions or diseases based on existing literature is also provided in Appendix A.

1. Please provide information about all health conditions or disease you were diagnosed with in the *{add number of years of interest}* by your doctor:

<b>Organ System</b>	<b>Condition (add additional rows as needed)</b>	<b>Year diagnosed</b>
Cardiovascular	<i>{Health condition or disease}</i>	
Endocrine (hormonal)	<i>{Health condition or disease}</i>	
Gastrointestinal	<i>{Health condition or disease}</i>	
Integumentary (dermal)	<i>{Health condition or disease}</i>	
Lymphatic	<i>{Health condition or disease}</i>	
Muscular	<i>{Health condition or disease}</i>	
Neurologic	<i>{Health condition or disease}</i>	
Reproductive	<i>{Health condition or disease}</i>	
Skeletal	<i>{Health condition or disease}</i>	
Other	<i>{Health condition or disease}</i>	

## Appendix A: Potential PFAS-associated Health Conditions

The following list may not be all-inclusive but contains PFAS-associated health conditions or diseases from epidemiologic studies that have been published in the peer-reviewed and scientific literature. This literature base is sparse; most studies examined only a small number of PFAS, most often PFOA, PFOS, and less often, PFHxS and PFNA. Many are cross-sectional studies (done at a single point in time) and some provide conflicting evidence on the association between PFAS exposure and the adverse health effects or health conditions under study. Investigators can tailor their health conditions of interest (Section C) based on concerns from their communities, the conditions or diseases listed below, and the current scientific literature.

Health conditions/diseases	Question Bank
Attention Deficit Hyperactivity Disorder (ADHD)	Adult and Children
Chronic kidney disease, specify type:	Adults only
Coronary artery disease	Adults only
Endometriosis	Adults only
High blood pressure	Adults only
High cholesterol (high LDL-C)	Adult and Children
Hyperthyroidism	Adult and Children
Hypothyroidism	Adult and Children
Kidney cancer	Adults only
Liver disease (non-infectious)	Adults only
Multiple sclerosis	Adults only
Osteoarthritis	Adults only
Osteoporosis	Adults only
Pre-eclampsia	Adults, can be consider for adolescent participants
Pregnancy-induced hypertension	Adults, can be consider for adolescent participants
Prostate cancer	Adults only
Rheumatoid arthritis	Adults only
Stroke	Adults only
Testicular cancer	Adults only
Ulcerative colitis	Adults only

**Example: Below is the example of health conditions by organ system for the health outcome section:**

Organ System	Condition (add additional rows as needed)	Year diagnosed
Cardiovascular	High blood pressure	
	High cholesterol (high LDL-C)	
	Coronary artery disease	
	Other:	
Renal	Chronic Kidney Disease, Specify: _____	
	Other:	

# PFAS Exposure Assessment: Invitation Letter and Consent Form, Assent Form for Minors

---

**Per- and Polyfluoroalkyl Substances (PFAS) have been detected in numerous public and private drinking water supplies in the United States. Health departments may use biomonitoring activities to assess exposure to PFAS. This document provides sample letters and forms that may be needed during a PFAS exposure assessment.**

## General Notes

---

This document contains two samples:

- Sample 1: Invitation Letter and Consent Form
- Sample 2: Assent Form for Minors

In the “Risks” section, the invitation letter specifies, “This exposure assessment requires 10 milliliters of blood (which is about 2 teaspoons).” However, you may want to contact the laboratory performing the analysis to see if smaller tubes can be used for children. You would need to modify the letter accordingly.

CDC’s IRB required that the assent of a minor child be sought when the child is seven years of age or older, unless the child’s decision-making capacity is impaired. For children between the age of 12 and the age of majority (18 years of age in 47 states, 19 in Alabama and Nebraska, 21 in Mississippi and Puerto Rico), investigators should use their judgment in deciding which of the required elements of informed consent would be most appropriate for their study population, allowing the older children in this group to use an assent form that closely follows the consent form used to consent adult participants.

Regarding confidentiality, some states have “sunshine laws” that require public release of any information in a state’s possession. State investigators should determine what information can be kept private and modify the confidentiality section in the invitation letter accordingly.

## Sample 1: Invitation Letter and Consent Form

You are invited to be a part of an assessment that will measure the levels of PFAS in your blood. The {insert name of health department} is trying to determine the level of PFAS in the blood of people who may have consumed contaminated drinking water while working, attending school or daycare, or living near the {insert name of city/town/place here}.

---

The main goal for this exposure assessment is to measure PFAS (or specify the type) blood levels in residents/employees of {insert name of city/town/place here}, who were exposed to contaminated drinking water. The {insert name of health department here} will conduct this exposure assessment from {insert dates here}. {add or change goals to fit the site- or community-specific need}

**This letter will explain the procedures, risks, and benefits of our exposure assessment to help you decide if you will participate.**

### Procedures for the Exposure Assessment

First, we will ask you to answer a few questions; the questionnaire should take less than 20 minutes to complete.

We will also ask you to give us a blood sample. A phlebotomist will draw a small amount of your blood for testing. We will label your samples with a code and date of birth only. Only the project coordinator will be able to identify whose blood the sample is from.

We will then send your blood sample to {insert name of the lab here} to measure the levels of PFAS. There will be no charge to you for the blood draw or the laboratory analysis. At the completion of the exposure assessment, {insert name of health department here} will mail your blood test results to you at the address you provided on the questionnaire. If you would like to talk with a physician about your results, one working on the exposure assessment will be available to you free of charge.

Any blood that is not needed for the measurements will be stored at the {insert name of the lab here} for the length of the exposure assessment. We will save the extra blood during this time in case the laboratory needs to repeat the test to check your results. Your blood samples will not be tested for any other chemicals or agents. Your PFAS level results (not including any information that would identify you personally) will also be used by the {insert name of health department here} and the Centers for Disease Control and Prevention for long-term understanding of PFAS exposure in the general population.

## You May Have Some Questions

### What are PFAS?

Per- and Polyfluoroalkyl Substances (PFAS) are a large group of man-made chemicals that were used in a wide range of industries.

Use of PFAS has greatly decreased in the past 10 years, but you can still be exposed to PFAS that are in the environment (water, soil, air) and in consumer products (food, cleaning products, personal care products, paints, and more).

PFAS are widely found in the environment and can persist in the human body for years. Scientists are not sure about the health effects of human exposure to PFAS.

### Why does the health department want to test my blood for PFAS?

We detected elevated levels of PFAS in the drinking water supply in your community. We want to determine the PFAS blood level of people exposed to the contaminated water.

### Who can I contact for more information?

If you have any questions about the exposure assessment, or about your rights as an exposure assessment participant, you can contact {insert name} by phone {insert number} or email {insert email}.

If you have any questions or concerns and you would like to talk to someone other than the project staff, you may contact the {insert name of health department here} at {insert phone number and email address here}.

Research to better understand the health effects associated with PFAS exposure is ongoing, but scientists are not currently certain of how PFAS levels in the blood can affect a person's health. More research is needed to clarify the risks posed by PFAS exposure. It is possible that new tests will be developed in the future that will increase our understanding of how PFAS impact human health. We would like to keep your blood sample so that scientists can test for more things if new tests are developed. To do this, we need your permission.

### **The Risks of Participating in Our Exposure Assessment**

This exposure assessment requires 10 milliliters of blood (which is about 2 teaspoons). You may feel a sharp sting from the needle used to draw your blood. Sometimes a bruise or small blood clot appears at the site. These bruises or clots usually go away on their own. Putting heat on the site can also help the bruise or clot to go away. Although it is not common, the needle could irritate a nerve. This irritation can cause numbness in part of the arm.

Risk of injury from the blood draw is higher for people with bleeding disorders, such as aplastic anemia, and for anyone on blood thinning medications (such as Coumadin) and other therapies. If you have such a bleeding disorder or are taking blood thinning medication, we recommend that you talk to your doctor before joining this exposure assessment. Infection could also develop as a result of the puncture through the skin. You or your health insurance company would be responsible for any follow-up care if you are injured as a result of the blood draw.

### **The Benefits of Participating in Our Exposure Assessment**

Your participation in this assessment will help us understand the range of PFAS exposure and possible exposure sources in your community. Work to better understand the health effects associated with PFAS exposure is ongoing, but scientists are not currently certain of how PFAS levels in the blood can affect a person's health. More research is needed to clarify the risks posed by PFAS exposure. Your participation in this assessment will help advance this research.

We will **not** be able to tell you if the PFAS levels in your blood will make you sick now or later in life. You will be able to call project staff during and after the exposure assessment if you have any questions about your results. If your doctor has questions about PFAS (*or specify type*), he or she may also call project staff or the physician working on the exposure assessment. The names and phone numbers of people to call are listed below.

### **Here is some additional information that will help you better understand our exposure assessment.**

- **Results:** *{insert name of health department here}* will send you a letter with your PFAS (*or specify the type*) level results along with how they compare to levels in other people in the United States. Some people may feel worried or anxious about their results. There is little we can tell you about what your results mean for your individual health. Exposure assessments of PFAS (*or specify the type*) and how they relate to health in people is not clear at this time, and we do not yet know enough to say whether there are levels in the blood that are safe or unsafe.
- **Confidentiality:** All personal identified information (such as name, address, date of birth) gathered for the exposure assessment is private. This information is protected by *{insert name of state here}* and federal law. Only project staff will have access to information that can identify you, and we will keep all of the information in a secure, locked database or file at all times. Aside from the *{insert name of health department here}* exposure assessment team, you are the only one who will receive your individual results.

- **Voluntary Participation:** Participation in this exposure assessment is completely voluntary. Your choice will not affect your current or future relationships with *{insert name of health department here}* or other groups that are part of the exposure assessment. If you decide to participate, you are free to quit the exposure assessment at any time. If project staff decide it is in your best interest, or if you fail to meet the exposure assessment qualifications, you may be removed from the exposure assessment without your consent.



## Consent Form

By marking the check boxes below and signing this form, you are confirming that you understand the goals of the exposure assessment, and that you agree, of your own free will, to participate. You are also confirming you will allow the project staff to collect, store, and share the information gathered for the exposure assessment as described above. You will receive a copy of this assent for your records.

I/my child agree to participate in the *{insert name of health department here}* Exposure Assessment.

Yes       No

I understand that I will receive my/my child's blood test results by mail. I will be able to compare my/child's (age 12 years or over) results with national averages.

Yes       No

I understand that project staff will not be able to determine if the PFAS (*or specify the type*) levels in my/child's blood will impact my health.

Yes       No

I agree that my results may be shared with other federal, state, and local environmental and health agencies. Your identifying information will be protected to the extent possible by law should you choose to share your results with other federal, state or local agencies.

Yes       No

I understand that my/my child's blood test and questionnaire data can be used for additional testing in the future.

Yes       No

I agree to allow my/my child's blood sample to be saved and used for other tests.

Yes       No

I agree that I may be contacted in the future for possible follow-up studies.

Yes       No

Participant's Name: \_\_\_\_\_  
(Printed)

Participant's Signature: \_\_\_\_\_

For child under the age of 18, Parent/legal guardian's signature: \_\_\_\_\_

Date Signed: \_\_\_\_\_

Invitation Letter and Consent Form, Assent Form for Minors

Street Address: \_\_\_\_\_

City: \_\_\_\_\_ State: \_\_\_\_\_ Zip: \_\_\_\_\_

Phone number (area code): \_\_\_\_\_

Project Coordinator's Name: \_\_\_\_\_

(Printed)

Project Coordinator's Signature: \_\_\_\_\_

## Sample 2: Assent Form for Minors

---

{Insert health department here} is doing an assessment on chemicals called PFAS. That stands for Per- and Polyfluoroalkyl Substances. Your parents have said that you could take part in the assessment, so we want to give you some information about it.

We found high levels of PFAS chemicals in the drinking water supply in {insert name of city/town/place here}. So we want to measure the amount of PFAS in the blood of people who may have come into contact with this contaminated water.

Different types of PFAS (or specify the type) are chemicals that were used in a wide range of ways in the United States. PFAS are found in the environment (in the air, soil, and water). And they can stay in the human body for years. Scientists are not sure how PFAS will affect people's health.

The main goal for this assessment is to find out how much PFAS (or specify the type) are in the blood of people in {Insert name of city/town/place here} who were exposed to contaminated drinking water. The {insert name of health department here} will conduct this assessment from {insert dates here}.

We hope you will agree to be part of this assessment. If you have any questions about this form at any time while filling it out, please don't hesitate to ask. Thank you for considering being in this assessment.

### Follow these instructions.

Please read this form. It contains information about the assessment and what will happen if you decide to participate. If you agree to take part in this assessment, please sign at the end of the form.

### What will happen?

If you choose to be in this assessment, we will draw about 10 milliliters of blood from a vein in your arm (that's about 2 teaspoons of blood). First we will clean the skin on your arm by gently rubbing it with alcohol. The needle stick may hurt a little for a few seconds. The person taking the blood will be very careful. Your blood samples will not have your name or other personal information on them. **Your blood will not be tested for HIV, or for the presence of alcohol or drugs.**

### You have the right to refuse or withdraw.

It is your choice whether to be in this assessment. You can expect the same medical care from your doctor whether you are in the assessment or not in the assessment. There is no penalty or loss of benefits if you choose not to be in this assessment. You may stop being in this assessment at any time without losing any benefits. If at any time in the future, you would like to have your blood sample destroyed or removed from the assessment, please call {insert name and phone number of Study coordinator}.

### Do you want more information?

We will give you a copy of this form to keep. If you have any questions, concerns, or complaints about this assessment, please contact the following people:

- If you have questions about this assessment or questions related to injury from the assessment, call {insert name and phone number of Study coordinator}.
- If you have questions about your rights as a participant in this assessment, please call {insert name and phone number of Study coordinator}.

Invitation Letter and Consent Form, Assent Form for Minors

Project Name: \_\_\_\_\_

Project Coordinator's Name: \_\_\_\_\_  
(Printed)

Project Coordinator's Signature: \_\_\_\_\_

**As described above, you are being asked to participate in an exposure assessment. You may participate by indicating your assent to the items below. You may assent to all, some, or none of the items.**

**To be in this assessment, please sign your initials in the box next to each item you agree to.**

I agree to have up to 10 milliliters (about 2 teaspoons) of my blood drawn from my arm by a needle (i.e., by vein puncture).  
(For children, contact the laboratory performing the analysis to see if smaller tubes can be used.)

I agree to have a portion of my blood sample stored for future research purposes and to be contacted in the future for possible follow up questions.

**I have read the assent form (or someone has read it to me), and I agree to be in this assessment. My initials above show which parts of the assessment I agree to participate in.**

Participant's Name: \_\_\_\_\_  
(Printed)

Participant's Signature: \_\_\_\_\_

**NOTE:** Based on state's requirement and procedures to conduct studies that include minors, you can ask minors to either sign the form or add a check box that indicates that a verbal assent was provided.

Date Signed: \_\_\_\_\_

Street Address: \_\_\_\_\_

City: \_\_\_\_\_ State: \_\_\_\_\_ Zip: \_\_\_\_\_

Phone number (area code): \_\_\_\_\_

# PFAS Exposure Assessment: Result Letters for Participants

---

Per- and Polyfluoroalkyl Substance (PFAS) have been detected in numerous public and private drinking water supplies in the United States. Health departments may use biomonitoring activities to assess exposure to PFAS. This document provides sample result letters that may be needed during a PFAS exposure assessment.

## General Notes

---

This document contains two sample letters:

- Sample 1: Letter of Results for Participants Ages 18 and Older
- Sample 2: Letter of Results for Participants Ages 3–17

## Sample 1: Participant Letter of Results for Ages 18 and Older

[Date]

[Name

Address

City, State, Zip code]

Dear [Insert Name],

Thank you for being a part of the [insert your department's name here] Per- and Polyfluoroalkyl substances (PFAS) exposure assessment. We tested your blood for PFAS. We are grateful for the time and effort you gave to this project. This letter provides your test results and explains what they mean. You may share these results with your doctor if you would like – it's your choice.

### The Results of Your Blood Test

Table 1 provides a list of all the specific PFAS that we measured in your blood. The table also lists the acronyms for the PFAS.

Table 2 shows the concentration of specific PFAS we found in your blood. The table also shows reference values for people in the United States, namely, the geometric mean and 95<sup>th</sup> percentile values.

Table 3 shows your results compared to results from other members in your community who also participated in this assessment. Your result is in units of micrograms per liter ( $\mu\text{g/L}$ ). One  $\mu\text{g/L}$  equals one part per billion, equivalent to about one drop of ink in a large tanker ship filled with water.

### A Little Help Interpreting the Results

Tables 2 and 3 provide a lot of information. And to fully understand all this information in the tables, you need to know about a survey called NHANES (the National Health and Nutrition Examination Survey).

Every year, the NHANES, as part of CDC, examines about 5,000 people from across the country. As part of the survey, CDC takes blood samples and tests them for chemicals like PFAS (among other things). The NHANES blood tests for PFAS chemicals in 2013–2014 come from a representative sample of members of the U.S. population (age 3 and older).

NHANES helps CDC estimate, for example, the levels of PFAS in the U.S. population. That is how we can compare the results of your blood test to reference values for people in the United States.

Now, let's talk about interpreting your results, presented in Tables 2 and 3. The diagrams below should help you understand the data we are giving you.

## Result Letters for Participants

This column lists all the different chemicals (PFAS) that we measured in your blood.

This column shows the geometric mean of results from the 2013–2014 NHANES survey (Table 2) or your community (Table 3).

PFAS	Your Level in $\mu\text{g/L}$	Geometric Mean in $\mu\text{g/L}$	95 <sup>th</sup> percentile in $\mu\text{g/L}$
PFBuS	[insert level]	*	< 0.1**

This column shows the concentration that we found in your blood.

This column shows the 95<sup>th</sup> percentile of results from the 2013–2014 NHANES survey (Table 2) or your community (Table 3).

A couple of important notes:

- If your PFAS result is in **bold**, then it exceeds the reference value (95<sup>th</sup> percentile). This means that your result exceeds what would be expected in about 95% of the U.S. population.
- If your result is not bold, then it does not exceed the reference value (95<sup>th</sup> percentile) and does not exceed what would be expected for 95% of the U.S. population.

### Tables 1, 2, and 3

Here are the results of your blood test.

**Table 1: List of measured PFAS and corresponding acronyms**

PFAS	Acronym
Perfluorobutanesulfonic acid	PFBS
Perfluorodecanoic acid	PFDA
Perfluorododecanoic acid	PFDoA
Perfluoroheptanoic acid	PFHpA
Perfluorohexane sulfonate	PFHxS
Perfluorononanoic acid	PFNA
Perfluorooctanoic acid	PFOA
Perfluorooctane sulfonate	PFOS
Perfluorooctane sulfonamide	FOSA
2-(N-Ethyl-perfluorooctane sulfonamido) acetate	EtFOSAA
2-(N-Methyl-perfluorooctane sulfonamido) acetate	MePFOSAA
Perfluoroundecanoic acid	PFUnDA

**Table 2: Your PFAS blood levels compared to what has been measured in the general U.S. Population**

PFAS	Your Level in $\mu\text{g/L}$	U.S. population Geometric Mean in $\mu\text{g/L}^{\text{a}}$	U.S. Population 95 <sup>th</sup> percentile in $\mu\text{g/L}^{\text{a}}$
PFBS	[insert level]	*	< 0.1**
PFDA		0.185	0.700
PFDoA		*	0.200
PFHpA		*	0.200
PFHxS		1.35	5.60
PFNA		0.675	2.00
PFOA		1.94	5.57
PFOS		4.99	18.5
FOSA		*	<0.1**
EtFOSAA		*	0.110
MePFOSAA		*	0.600
PFUnDA		*	0.500

Note: Above results from NHANES 2013–2014, except PFOSA and Et-PFOSA-AcOH which are from 2011-2012. ND – Not detected. \* Geometric mean was not calculated because not enough people had results that were detectable. \*\*95<sup>th</sup> percentile was below the limit of detection, 0.1  $\mu\text{g/L}$ .

<sup>a</sup> Source: CDC. The National Report on Human Exposure to Environmental Chemicals, Updated Tables, March 2018. Available at: <https://www.cdc.gov/exposurereport/>.



**Table 3: Your PFAS blood levels compared to other people who participated in this assessment from [insert community name]**

PFAS	Your Level (µg/L)	Geometric Mean in µg/L (# participants)	95 <sup>th</sup> percentile in your community in µg/L
PFBS	[insert level]	[insert mean]	[insert value]
PFDA			
PFDoA			
PFHpA			
PFHxS			
PFNA			
PFOA			
PFOS			
FOSA			
EtFOSAA			
MePFOSAA			
PFUnDA			
ND- Not detected.			

### **What Do These Results Mean to Your Health?**

These results tell you how much PFAS is currently present in your blood from all sources combined, such as water, food, and other environmental sources. You can compare your results with others from your community and also people across the United States.

Scientists are not sure about the health effects of human exposure to PFAS. Some studies in humans have shown that certain PFAS may affect the developing fetus and child, including possible changes in growth, learning, and behavior. In addition, PFAS may decrease fertility and interfere with the body's natural hormones, increase cholesterol, affect the immune system, and possibly increase cancer risk.

While scientific research on PFAS is growing, for now these blood test results cannot tell you:

- If a current health problem is related to the PFAS levels found in your body.
- If the PFAS levels in your body will make you sick now or later in life.
- How and where you were exposed.
- When or how often you were exposed.
- How long the exposure lasted.
- How much of the chemical you were exposed to.

Your results, when combined with others, may help us better understand any potential health risks from PFAS exposure in the future.

### **What about Your Exposure? [Include only one category below]**

[Use for results below reference values compared to NHANES or community]

- Your blood sample showed that your PFAS levels are within the values of what has been reported for people living in US or in the [insert community name] community.
- Please see the included handouts for more information about PFAS and how to reduce your exposure.

[Use for results above reference values compared to NHANES or community]

- While your results were above the 95% percentile found in the people living in the United States or in the [insert community name], it is important to remember that scientists do not know what these levels mean in terms of affecting your health, if at all.
- Please see the included handouts for more information about PFAS and how to reduce your exposure.

### **Next Steps**

Please call [phone number] at [DOH] to discuss any questions you may have. Your personal test results will be kept private and confidential. Your results may be combined with other participants in your community and used in a summary report; however, no one will be able to identify you.

### More Information

- If you or your doctor have any medically related questions about these results or wish to further discuss these results, please contact [name] by phone [number] or email [email].
- **For additional information about PFAS from [DOH], please visit [web address].**
- For additional information about PFAS from the CDC and the Agency for Toxic Substances and Disease Registry, please visit: <http://www.atsdr.cdc.gov/pfc/index.html>.
- For additional information about PFAS from the U.S. Environmental Protection Agency, please visit: <https://www.epa.gov/chemical-research/research-and-polyfluoroalkyl-substances-pfas>.

Thank you again for being part of the PFAS assessment.

## Sample 2: Participant Letter of Results for Ages 17 and Younger

[Note: For ages 11 and under, consider removing Table 2 and including community comparison results ONLY from Table 3. Alternatively, there are some published studies that contain reference ranges for certain populations such as *Morck et.al. Chemosphere 129 (2015) pp 203-209*]

[Date]

To the parents or guardians of:

[Name

Address

City, State, Zipcode]

Dear [Insert parent/guardian name],

Thank you for being a part of the [insert your department's name here] Per- and Polyfluoroalkyl substances (PFAS) exposure assessment. We tested your child's blood for PFAS. We are grateful for the time and effort given to this project. This letter is to give you your child's test results and to explain what they mean. You may share these results with your child's doctor if you would like – it's your choice.

### The Results of Your Child's Blood Test

Table 1 provides a list of all the specific PFAS that we measured in your child's blood. The table also lists the acronyms for the PFAS.

Table 2 shows the concentration of PFAS we found in your child's blood. The table also shows reference values for people in the United States, namely, the geometric mean and 95th percentile values.

Table 3 shows your child's results compared to results from other members in your community who also participated in this assessment. Your result is in units of micrograms per liter ( $\mu\text{g/L}$ ). One  $\mu\text{g/L}$  is the same as about one drop of ink in a large tanker ship filled with water.

### A Little Help Interpreting the Results

Tables 2 and 3 provide a lot of information. And to fully understand all this information in the tables, you need to know about a survey called NHANES (the National Health and Nutrition Examination Survey).

Every year, the NHANES, a part of CDC, examines about 5,000 people from across the country. As part of the survey, CDC takes blood samples and tests them for chemicals like PFAS (among other things). The NHANES blood tests for PFAS chemicals come from a representative sample of members of the U.S. population (age 12 and older). In 2013–2014, NHANES measured PFAS in a sample of children ages 3 to 11 years, so that reference ranges could be determined in younger children. However, there are not NHANES results for children younger than 3 years.

## Result Letters for Participants

NHANES helps CDC estimate, for example, the levels of PFAS in the U.S. population. That is how we can compare the results of your blood test to reference values for people in the United States.

Now, let's talk about interpreting your child's results, presented in Tables 2 and 3. The diagrams below should help you understand the data we are giving you.

This column lists all the different chemicals (PFAS) that we measured in your child's blood.

This column shows the geometric mean of results from the 2013–2014 NHANES survey age group 12-19 years (Table 2) or your community (Table 3).

PFAS	Your Level in $\mu\text{g/L}$	Geometric Mean in $\mu\text{g/L}$	95 <sup>th</sup> percentile in $\mu\text{g/L}$
PFBuS	<b>[insert level]</b>	*	< 0.1**

This column shows the concentration that we found in your child's blood.

This column shows the 95<sup>th</sup> percentile of results from the 2013–2014 NHANES survey age group 12-19 years (Table 2) or your community (Table 3).

A couple of important notes:

- If the PFAS result is in bold, then than it exceeds the reference value (95th percentile). This means that your result exceeds what would be expected in about 95% of the U.S. population.
- If the result is not bold, then it does not exceed the reference value (95th percentile) and does not exceed what would be expected for 95% of the U.S. population.

**Tables 1, 2, and 3**

Here are the results of your child's blood test.

**Table 1: List of measured PFAS and corresponding acronyms**

<b>PFAS</b>	<b>Acronym</b>
Perfluorobutanesulfonic acid	PFBS
Perfluorodecanoic acid	PFDA
Perfluorododecanoic acid	PFDoA
Perfluoroheptanoic acid	PFHpA
Perfluorohexane sulfonate	PFHxS
Perfluorononanoic acid	PFNA
Perfluorooctanoic acid	PFOA
Perfluorooctane sulfonate	PFOS
Perfluorooctane sulfonamide	FOSA
2-(N-Ethyl-perfluorooctane sulfonamido) acetate	EtFOSAA
2-(N-Methyl-perfluorooctane sulfonamido) acetate	MeFOSAA
Perfluoroundecanoic acid	PFUnDA

**Table 2:**

**Your child's PFAS blood levels compared to what has been measured in children ages 3 to 17 years in the general U.S. Population (not available for children younger than 3 years)**

PFAS	Your Level in $\mu\text{g/L}$	U.S. Population Geometric Mean in $\mu\text{g/L}^{\text{a}}$	U. S. Population, ages 3 to 17 years 95 <sup>th</sup> percentile in $\mu\text{g/L}^{\text{a}}$
PFBS	[insert level]	*	< 0.1**
PFDA		*	0.340
PFDoA		*	<0.1**
PFHpA		*	0.200
PFHxS		0.975	2.960
PFNA		0.713	2.690
PFOA		1.815	3.99
PFOS		3.645	9.770
FOSA		*	<0.1**
EtFOSAA		*	< 0.1**
MePFOSAA		*	0.860
PFUnDA		*	0.250

Note: Above results from NHANES 2013–2014, except FOSA and Et-PFOSA-AcOH which are from 2011-2012. ND – Not detected. \*Geometric mean was not calculated because not enough people had results that were detectable. \*\*95<sup>th</sup> percentile was below the limit of detection (0.1  $\mu\text{g/L}$ ).

<sup>a</sup> Source: CDC. The National Health and Nutrition Examination Survey (NHANES). 2013–2014

Laboratory Data. Available at:

<https://wwwn.cdc.gov/nchs/nhanes/search/datapage.aspx?Component=Laboratory&CycleBeginYear=2013>

**Table 3: Your child’s PFAS blood levels compared to other people who participated in this assessment from [insert community name]**

PFAS	Your Level (µg/L)	Geometric Mean In µg/L (# participants)	95 <sup>th</sup> percentile in your community for ages x-xx in µg/L
PFBS	[insert level]	[insert mean]	[insert value]
PFDA			
PFDoA			
PFHpA			
PFHxS			
PFNA			
PFOA			
PFOS			
FOSA			
EtFOSAA			
MePFOSAA			
PFUnDA			
ND- Not detected.			



### **What Do These Results Mean to Your Child's Health?**

These results tell you how much PFAS is currently present in your child's blood from all sources combined, such as water, food, and other environmental sources. You can compare your child's results with others from your community and also people across the United States.

Scientists are not sure about the health effects of human exposure to PFAS. Some studies in humans have shown that certain PFAS may affect the developing fetus and child, including possible changes in growth, learning, and behavior. In addition, PFAS may decrease fertility and interfere with the body's natural hormones, increase cholesterol, affect the immune system, and possibly increase cancer risk.

While scientific research on PFAS is growing, for now these blood test results cannot tell you:

- If a current health problem is related to the PFAS levels found in the body.
- If the PFAS levels in the body will make your child sick now or later in life.
- How and where was your child exposed.
- When or how often was your child exposed.
- How long the exposure lasted.
- How much of the chemical your child was exposed to.

These results, when combined with others, may help us better understand any potential health risks from PFAS exposure in the future.

### **What about Your Child's Exposure? [Include only one category below]**

[Use for results below reference values from NHANES or community]

- Your blood sample showed that your child's PFAS levels are within the values of what has been reported for people living in the United States or in the [insert community name] community.
- Please see the included handouts for more information about PFAS and how to reduce your child's exposure.

[Use for results above reference values from NHANES or community]

- While your child's results were above the 95% percentile found in U.S. children ages 3 to 17 years or in the [insert community name], it is important to remember that scientists do not know what these levels mean in terms of affecting your child's health, if at all.
- Please see the included handouts for more information about PFAS and how to reduce your child's exposure.

### **Next Steps**

Please call [phone number] at [DOH] to discuss any questions you may have. Your child's test results will be kept private and confidential. Your child's results may be combined with other participants in your community and used in a summary report; however, no one will be able to identify your child.

### More Information

- If you or your child's doctor have any medically related questions about these results or wish to further discuss these results, please contact [name] by phone [number] or email [email].
- **For additional information about PFAS from [DOH], please visit [web address].**
- For additional information about PFAS from the CDC and the Agency for Toxic Substances and Disease Registry, please visit: <http://www.atsdr.cdc.gov/pfc/index.html>.
- For additional information about PFAS from the U.S. Environmental Protection Agency, please visit: <https://www.epa.gov/chemical-research/research-and-polyfluoroalkyl-substances-pfas>.

Thank you again for your child's participation in the PFAS assessment.

# PFAS Exposure Assessment: Serum Collection Protocol

(Based on CDC Protocol)

**Per- and Polyfluoroalkyl Substance (PFAS) have been detected in numerous public and private drinking water supplies in the United States. Health departments may need help determining how to best assess exposure to PFAS. This document provides serum collection protocols to follow when conducting PFAS biomonitoring activities.**

## General Notes

Universal (Standard) Precautions should be adhered to as defined in the OSHA Blood-borne Pathogens Standard (29 CFR 1910.1030).

Instruct each participant to drink plenty of water (i.e., one to two 8 ounce glasses) at least an hour before blood collection.

Some of the specific details described below (e.g., bar-coded labels, format of the specimen log, shipping container labels) are provided as illustrations and may differ depending on the laboratory that will be analyzing the samples. Protocol details regarding serum collection, handling, storage, and transportation should be reviewed and discussed with the laboratory prior to beginning the sample collection.

## Serum Collection Procedure

- 1) Collect the red-top tube for serum. Allow the tube to clot 30 minutes to 1 hour, then centrifuge the tube to separate the serum. Afterward, transfer the serum to a 2 ml cryovial or vial provided by the laboratory making the measurements.
- 2) Label the tubes with the preprinted bar-coded labels provided, and use a permanent marker to add the date collected to the label.

Be sure to label each container with the appropriate bar-coded label supplied by the laboratory. For example, labels should be affixed to each container so that the barcode resembles a ladder.

### Materials Needed (Per Participant)

- Red-top tube  
(1 filled 10 ml red top tube will yield 4-6 ml serum)  
Note: For children, contact the laboratory performing the analysis to see if smaller tubes can be used.
- Butterfly collection needles (23 gauge)
- Gauze sponges, alcohol pads, and adhesive bandages
- Disposable gloves
- Preprinted bar-coded labels
- Tourniquets

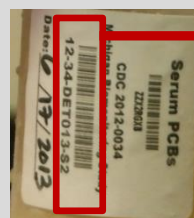

Place the label so that the barcode looks like a ladder (vertical on the vial).

## Serum Processing Procedure

---

1) Blood is collected in red-top collection tubes. Red-top tubes should **not** be inverted or mixed. Label all tubes. Place the red-top tubes upright in a rack and allow them to clot for 60 minutes. Serum samples that are allowed to sit less than 30 minutes are likely to retain cellular elements and other contaminants that will adversely affect future analysis. Samples that sit longer than 60 minutes are likely to experience lysis of cells in the clot, causing release of cellular components not usually found in serum samples.

### Materials and Equipment Needed (Per Participant)

- Disposable gloves
- Disposable transfer pipets
- Cryovial for serum PFAS (2mL)
- Preprinted bar-coded labels
- Sample boxes
- Centrifuge (e.g., small bench-top centrifuge that can hold blood tubes and conforms to clinical and safety standards)
- Bio-safety cabinet/fume hood
- Freezer (-20°C) or dry ice

2) Centrifuge the red-top tubes for 15 minutes at 1000 to 1300 g-force.

3) Prepare all aliquots in a bio-safety cabinet, if available, to reduce the risk of sample contamination. Using a transfer pipette, pipette no more than 1.8 mls of the serum (preferably free and clear of red cells), from each participant's red-top tube into a 2mL cryovial or tube provided by the laboratory. Place the cap on the 2 ml cryovial. Note on the sample log if a sample is turbid or hemolyzed. Place the containers upright in the sample boxes and store in a freezer at or below -20°C until ready to ship.

4) Use a collection log. Place a label in the space provided to indicate which aliquots were collected for each participant. Record in the comments section any variations from the protocol for collection, processing, or storage. Once collections are completed, include the collection log with the shipment. Retain a copy for your records.

Serum Collection Protocol

<b>PFAS Study</b>	
SHIPMENT DATE: _____	RECEIPT DATE: _____
SHIPPED BY: _____	RECEIVED BY: _____

☐=SPECIMEN COLLECTED

X=SPECIMEN NOT COLLECTED

LABEL			COMMENTS: _____	LABEL			COMMENTS: _____
			_____				_____
			_____				_____
			_____				_____
LABEL			COMMENTS: _____	LABEL			COMMENTS: _____
			_____				_____
			_____				_____
			_____				_____
LABEL			COMMENTS: _____	LABEL			COMMENTS: _____
			_____				_____
			_____				_____
			_____				_____

**Shipping Procedure**

- 1) Use storage boxes for each vial/tube type. Place each of these boxes inside a biohazard bag along with an absorbent pad, and snap the bag shut.
- 2) For the serum, place the bagged specimen boxes inside a styrofoam shipping container. Then, fill the container with dry ice. Add some packing material, and close up the shipper.
- 3) Place the following labels on the outside of the shipping container.
- 4) Notify the laboratory by phone, fax, or email the day you ship the package. Ship only on Monday through Thursday to insure that the package will arrive during a regular workday and not over a weekend day or holiday.

## PFAS Exposure Assessment: Non-Federal Laboratories That Measure PFAS

---

A limited number of laboratories have the capability to measure PFAS in biological specimens. These laboratories are not affiliated with CDC. To request this information, please email a written request to [pfas@cdc.gov](mailto:pfas@cdc.gov).



## Laboratory Procedure Manual

*Analyte:* **Polyfluoroalkyl Substances: 2-(N-methyl-perfluorooctane sulfonamido) acetate, perfluorobutane sulfonate, perfluorohexane sulfonate, n-perfluorooctane sulfonate, sum of perfluoromethylheptane sulfonate isomers, sum of perfluorodimethylhexane sulfonate isomers, perfluoroheptanoate, n-perfluorooctanoate, sum of branched perfluorooctanoate isomers, perfluorononanoate, perfluorodecanoate, perfluoroundecanoate, and perfluorododecanoate**

*Matrix:* **Serum**

*Method:* **Online Solid Phase Extraction-High Performance Liquid Chromatography-Turbo Ion Spray-Tandem Mass Spectrometry (Online SPE-HPLC-TIS-MS/MS)**

*Method No:* **6304.06**

*As performed by:*

Organic Analytical Toxicology Branch  
Division of Laboratory Sciences  
National Center for Environmental Health

*Contact:*

Xiaoyun (Sherry) Ye, M.S.  
Phone: 770.488.7502  
Email: XYe@cdc.gov

James L. Pirkle, M.D., Ph.D.  
Director, Division of Laboratory Sciences

### **Important Information for Users**

The Centers for Disease Control and Prevention (CDC) periodically refines these laboratory methods. It is the responsibility of the user to contact the person listed on the title page of each write-up before using the analytical method to find out whether any changes have been made and what revisions, if any, have been incorporated.

## Public Release Data Set Information

This document details the Lab Protocol for testing the items listed in the following table:

File Name	Variable Name	SAS Label (and SI units)
PFAS_H	LBXPFDE	Perfluorodecanoic acid (ng/mL)
	LBXPFHS	Perfluorohexane sulfonic acid (ng/mL)
	LBXMPAH	2-(N-methyl-PFOSA) acetic acid (ng/mL)
	LBXPFBS	Perfluorobutane sulfonic acid (ng/mL)
	LBXPFHP	Perfluoroheptanoic acid (ng/mL)
	LBXPFNA	Perfluorononanoic acid (ng/mL)
	LBXPFUA	Perfluoroundecanoic acid (ng/mL)
	LBXPFDO	Perfluorododecanoic acid (ng/mL)
SSPFAS_H	SSNPFOA	Linear perfluorooctanoate (ng/mL)
	SSBPFOA	Branched isomers of perfluorooctanoate (ng/mL)
	SSNPFOS	Linear perfluorooctane sulfonate (ng/mL)
	SSMPFOS	Monomethyl branched isomers of PFOS (ng/mL)

### 1. Clinical Relevance and Summary of Test Principle

#### a. Clinical Relevance

Some per- and polyfluoroalkyl substances (PFASs), including perfluorooctane sulfonate (PFOS) and perfluorooctanoate (PFOA), persist in humans and the environment and have been detected worldwide in wildlife<sup>1</sup>. Exposure to PFOS and PFOA in the general population is also widespread, although demographic, geographic, and temporal differences exist<sup>2-14</sup>. In animals, exposure to PFOS and PFOA is associated with adverse health effects<sup>15-17</sup> albeit at serum concentrations orders of magnitude higher than the concentrations observed in the general population<sup>18,19</sup>. PFOS was used in a wide variety of industrial and consumer products including protective coatings for carpets and apparel, paper coatings,



insecticide formulations, and surfactants. In 2000, 3M, the sole manufacturer of PFOS in the United States and the principal manufacturer worldwide, announced that it was discontinuing its perfluorooctanyl chemistries, including PFOS. Shortly after, EPA also identified possible related concerns with respect to PFOA and fluorinated telomers. PFOA has been used primarily to produce its salts which are used in the production of fluoropolymers and fluoroelastomers. These polymers are used in many industrial and consumer products, including soil, stain, grease, and water resistant coatings on textiles and carpet; uses in the automotive, mechanical, aerospace, chemical, electrical, medical, and building/construction industries; personal care products; and nonstick coatings on cookware.

The electrochemical fluorination (ECF) manufacturing method used from the 1950s until the early 2000s to produce PFASs including PFOA, and PFOS and its precursors yielded branched and linear isomers. By contrast, another method, telomerization, produces almost exclusively linear compounds<sup>20</sup>. The structural isomer patterns of PFOA and PFOS in humans may be useful for understanding routes and sources of exposure<sup>20</sup>.

## b. Test Principle

Online solid phase extraction coupled to high performance liquid chromatography-turboionspray ionization-tandem mass spectrometry (online SPE-HPLC-TIS-MS/MS) is used for the quantitative detection of PFASs: 2-(N-methyl-perfluorooctane sulfonamido) acetate (Me-PFOSA-AcOH), perfluorobutane sulfonate (PFBS), perfluorohexane sulfonate (PFHS), n-perfluorooctane sulfonate (n-PFOS), sum of perfluoromethylheptane sulfonate isomers (Sm-PFOS, monomethyl branched isomers of PFOS), sum of perfluorodimethylhexane sulfonate isomers (Sm<sub>2</sub>-PFOS, dimethyl branched isomers of PFOS), perfluoroheptanoate (PFHpA), n-perfluorooctanoate (n-PFOA), sum of branched perfluorooctanoate isomers (Sb-PFOA, branched PFOA isomers), perfluorononanoate (PFNA), perfluorodecanoate (PFDeA), perfluoroundecanoate (PFUA), and perfluorododecanoate (PFDoA)<sup>21</sup>. Briefly, after dilution with formic acid, one aliquot of 50  $\mu$ L of serum is injected into a commercial column switching system allowing for concentration of the analytes on solid-phase extraction column. Separation of the analytes from each other and from other serum components is achieved with high-performance liquid chromatography. Detection and quantification are done using negative-ion TurboIonSpray ionization, a variant of electrospray ionization, tandem mass spectrometry. This method allows for rapid detection of these PFASs in human serum with limits of detection in the low parts per billion (ppb or ng/mL) range.

## 2. Safety Precautions

### a. Reagent Toxicity or Carcinogenicity

Some of the reagents used are toxic. Special care should be taken to: 1) Avoid contact with eyes and skin, 2) avoid use of the organic solvents in the vicinity of an open flame, and 3) use solvents only in well-ventilated areas.

Note: Material Safety Data Sheets (MSDS) for the chemicals and solvents used in this procedure can be found at [www.ilpi.com/msds/index.html](http://www.ilpi.com/msds/index.html); some of them may be found in a binder in the laboratory. Laboratory personnel are advised to review the MSDS before using chemicals.

Care should be exercised in the handling of all chemical standards.

**b. Radioactive Hazards**

None.

**c. Microbiological Hazards**

The possibility of being exposed to various microbiological hazards exists. Appropriate measures (i.e., universal precautions) should be taken to avoid any direct contact with biological specimens (i.e., use gloves, laboratory coats, safety glasses, chemical or biological hoods). Any residual biological material should be appropriately discarded and prepared for autoclaving after analysis is completed. All disposable laboratory supplies must also be placed in an autoclave bag for disposal. The Hepatitis B vaccination series is recommended for health care and laboratory workers who are exposed to human fluids and tissues. Laboratory personnel who handles human fluids and tissues is required to take the "Bloodborne Pathogens Training" course offered at CDC to insure proper compliance with CDC safe work place requirements.

**d. Mechanical Hazards**

There are only minimal mechanical hazards when performing this procedure using standard safety practices. Laboratorians should avoid any direct contact with the electronics of the mass spectrometer, unless all power to the instrument is off. Generally, only qualified technicians should perform the electronic maintenance and repair of the mass spectrometer. Contact with the heated surfaces of the mass spectrometer (e.g., interface) should be avoided.

**e. Protective Equipment**

Standard safety protective equipment should be utilized when performing this procedure. This includes lab coat, safety glasses, durable gloves (e.g., nitrile or vinyl), and/or a chemical fume hood or biological safety cabinet.

**f. Training**

Training and experience in the use of a triple quadrupole mass spectrometer and the on-line SPE extractor should be obtained by anyone using this procedure. Operators are required to read the operation manuals or laboratory SOP. Formal training is not necessary; however, an experienced user should train all of the operators.

### **g. Personal Hygiene**

Care should be taken in handling any biological specimen. Routine use of gloves and proper hand washing should be practiced. No food or drink is allowed in laboratory areas.

### **h. Disposal of Wastes**

Solvents and reagents are disposed of in an appropriate container clearly marked for waste products and temporarily stored in one of the chemical fume hoods. Containers, glassware, etc., that come in direct contact with the specimen are either autoclaved or decontaminated with 10% bleach. Contaminated analytical glassware is treated with bleach, washed and reused; disposable labware is autoclaved before disposal. To insure proper compliance with CDC requirements, laboratory personnel are required to attend annual hazardous waste disposal courses.

## **3. Computerization; Data-System Management**

### **a. Software and Knowledge Requirements**

All samples are queued for analysis in a database created using Microsoft Access. Mass spectrometry data are collected and stored using the Analyst Software of the ABI 5500 and ABI 6500 Qtrap mass spectrometers. During sample preparation and analysis, samples are identified by their Sample Name and Sample ID. The Sample Name is used to identify each specimen and links the laboratory information with the demographic data recorded by the sample takers. The Sample ID is used to identify each specimen and links the laboratory information with the demographic data recorded by the sample takers. In case of repeated measurements, one specimen in the database may have more than one Sample Name, but only one Sample ID. All raw data files are processed using the Analyst software and are archived for future reference. The Analyst software selects the appropriate peak based on the precursor/product ion combination and chromatographic retention time and subsequently integrates the peak area. It also allows manual peak selection and area integration. The raw data (peak area, peak height, retention time, analyte name, MRM transition name) are exported to the Access database used for storage and retrieval of data. The Access database is stored on a network drive; it may also be backed up in additional archive locations. Statistical analysis of the data, programming, and reporting are performed using the Statistical Analysis System (SAS) software (SAS Institute, Cary, NC). Knowledge and experience with these software packages (or their equivalent) are required to utilize and maintain the data management structure.

### **b. Sample Information**

Sample names and Sample IDs are entered into the Access database before sample preparation. If possible, for unknown samples, sample study IDs are read in by a barcode reader directly from the vials labels. Sample names for Standards, and Blanks (SBs, HSBs, QCBs) are entered manually. The Sample Log Sheet, containing Sample Names, Sample IDs, and sample study IDs is printed from the Access database and is used to record information during sample preparation. Sample Names, Sample IDs, and sample study IDs are exported as tab delimited

text files from the Access database and imported into the Acquisition Batch table (\*.dab) of the Analyst program on the mass spectrometer. After MS data collection and peak integration, data are saved as a tab delimited file and imported into the Access database. Further manipulation of the data, including QC evaluation and statistical analyses, are performed using SAS statistical software. After any additional calculations or corrections by the analyst are completed and the reviewing supervisor approves the final values for release, a comma-delimited file (SAS output) is generated.

### **c. Data Maintenance**

Raw files are regularly backed up onto an external hard drive. Sample and analytical data are checked after being entered into the database for transcription errors and overall validity. The database is routinely backed up onto a computer hard drive and onto a network drive. Data from completed studies are saved on an external hard drive and/or a network drive. Additionally, paper copies of signed final report memos are scanned and saved as official government records.

## **4. Procedures for Collecting, Storing, and Handling Specimens; Criteria for Specimen Rejection**

### **a. Sample Collection and Storage**

Follow recommended phlebotomy practices for the collection of blood and separation of blood serum. Preferably, a minimum of 0.5 mL of serum (plasma may also be used) should be placed in standard collection containers, refrigerated as soon as possible, and transferred to labeled containers for storage. Sera should be stored frozen preferably in polypropylene or polyethylene containers. Glass containers may be used if the specimens are to be analyzed for other environmental chemicals for which storage in plastic may be a problem. Teflon® coated materials should be avoided.

### **b. Sample Handling**

In general, serum specimens should be shipped or transported cold (dry ice, ice or blue ice can be used). Special care must be taken in packing to protect vials from breakage during shipment.

Before analysis, samples are thawed, vortexed, aliquoted, and the residual specimen is refrozen and stored. The integrity of samples thawed and refrozen several times doesn't appear to be compromised.

### **c. Criteria for Specimen Rejection**

Specimens can be rejected if tubes/vials leaked, are broken, appear compromised or tampered with, or hold inadequate volume for analysis.

## **5. Procedures for Microscopic Examinations; Criteria for Rejecting Inadequately Prepared Slides**

Not applicable for this procedure.

## 6. Preparation of Reagents, Calibration (Standards), Controls, and All Other Materials; Equipment and Instrumentation

### a. Reagents and Sources

Methanol (MeOH), acetonitrile, and water were HPLC grade purchased from Honeywell Burdick & Jackson (Muskegon, MI). Formic acid (99%) was purchased from EM Science (Gibbstown, NJ). Acetic acid (glacial) was purchased from J.T. Baker (Phillipsburg, NJ). The following PFASs were purchased from Wellington Laboratories (Guelph, ON, Canada): N-methylperfluoro-1-octanesulfonamidoacetic acid (Me-PFOSA-AcOH), sodium perfluoro-1-hexanesulfonate (PFHxS), potassium perfluoro 1-buthanesulfonate (PFBuS), sodium perfluoro 1-octanesulfonate (n-PFOS), mixture of sodium perfluoro-5-methylheptane sulfonate (P5MHpS) and perfluoro-5-methylheptanoic acid (P5MHpA), mixture of sodium perfluoro-5,5-dimethylhexane sulfonate (P55DMHxS) and perfluoro-5,5-dimethylhexanoic acid (P55DMHxA), perfluoroheptanoic acid (PFHpA), ammonium perfluorooctanoate (n-PFOA), perfluorononanoic acid (PFNA), perfluorodecanoic acid (PFDeA), perfluoroundecanoic acid (PFUA), and perfluorododecanoic acid (PFDoA). Perfluoro-n-[1,2,3,4,5-<sup>13</sup>C]-heptanoic acid (<sup>13</sup>C5-PFHpA), perfluoro-n-[1,2,3,4,5-<sup>13</sup>C]-octanoic acid (<sup>13</sup>C4-PFOA), perfluoro-n-[1,2,3,4,5-<sup>13</sup>C]-nonanoic acid (<sup>13</sup>C5PFNA), 2-Perfluorooctyl [1,2-<sup>13</sup>C]-ethanoic acid (<sup>13</sup>C2-PFDeA), 2-perfluorooctyl [1,2-<sup>13</sup>C]-undecanoic acid (<sup>13</sup>C2-PFUA), perfluoro-n-[1,2-<sup>13</sup>C]-dodecanoic acid (<sup>13</sup>C2-PFDoA), N-methyl-d3-perfluoro-1-octanesulfonamide acetic acid (D3-MePFOSA-AcOH), and sodium perfluoro 1-hexane [<sup>18</sup>O<sub>2</sub>]-sulfonate (<sup>18</sup>O<sub>2</sub>-PFHxS), sodium perfluoro 1-[1,2,3,4-<sup>13</sup>C]-octanesulfonate (<sup>13</sup>C4-PFOS) were purchased from Wellington Laboratories. All reagents were used without further purification. Other standards and reagents with similar specifications may be used.

### b. Working Solutions

#### (1) HPLC Mobile Phase, 20mM Ammonium Acetate Buffer/acetonitrile (95:5), pH 4.

To prepare 20 mM Ammonium acetate buffer (pH4.0), dilute 1140  $\mu$ L of concentrated acetic acid with approximately 800 mL water in a beaker. Adjust pH to 4 $\pm$ 0.1 by adding drop-wise 1:10 ammonium hydroxide:water mixture. Transfer into a 1 L volumetric flask and fill up to volume with deionized water.

Mix 950 mL of ammonium acetate buffer with 50 mL of acetonitrile in a glass bottle. Prepare as needed and store at room temperature.

#### (2) HPLC Organic Mobile Phase, 100% HPLC acetonitrile

Refill as needed and store at room temperature.

#### (3) Organic solvent for SPE column regeneration, 100% Acetonitrile

Refill as needed and store at room temperature.

**(4) Solid phase extraction (SPE) Acid Wash Solution, 0.1M formic acid**

Dilute 3810  $\mu\text{L}$  of 99% concentrated formic acid with water to 1000 mL in a volumetric cylinder. Prepare monthly and store at room temperature.

**c. Standards Preparation****(1) Analytical Calibration Standards**

The native standard stock solutions of all the analytes are prepared in methanol from the commercial solutions. The concentrations of the commercial solutions are: 50  $\mu\text{g}/\text{mL}$  for Me-PFOSA-AcOH and n-PFOS; 2  $\mu\text{g}/\text{mL}$  for PFHxS, PFBuS, n-PFOS, PFHpA, n-PFOA, PFNA, PFDeA, PFUA, and PFDoA; 1  $\mu\text{g}/\text{mL}$  for P5MHpS and P55DMHxS; 1.96  $\mu\text{g}/\text{mL}$  for P5MHpA and P55DMHxA. We used P5MHpS to quantify Sm-PFOS and P55DMHxS to quantify Sm<sub>2</sub>-PFOS. We used the combined response of the P5MHpA and P55DMHxA standards for the quantitation of Sb-PFOA. The PFOA isomers known to be included in Sb-PFOA are perfluoro-3methylheptanoic acid, perfluoro-4-methylheptanoic acid, perfluoro-5methylheptanoic acid, perfluoro-6-methylheptanoic acid, perfluoro-4,4dimethylhexanoic acid, perfluoro-5,5-dimethylhexanoic acid, perfluoro-3,5dimethylhexanoic acid, and perfluoro-4,5-dimethylhexanoic acid. Similarly, the PFOS isomers known to be included in Sm-PFOS are perfluoro-3methylheptane sulfonate, perfluoro-4-methylheptane sulfonate, perfluoro-5-methylheptane sulfonate, perfluoro-6-methylheptane sulfonate. The PFOS isomers known to be included in Sm<sub>2</sub>-PFOS are perfluoro-4,4dimethylhexane sulfonate, perfluoro-5,5-dimethylhexane sulfonate, perfluoro-4,5-dimethylhexane sulfonate, and perfluoro-3,5-dimethylhexane sulfonate.

The spiking standard solutions are prepared in MeOH from native standard stock solutions such as a 50- $\mu\text{L}$  spike into 50  $\mu\text{L}$  serum provides concentrations that cover the linear range of the method (Table 1). The spiking solutions are stored frozen in 1.0 mL aliquots in polypropylene cryogenic vials until use.

**Table 1. Concentrations of standards #1-9 (in  $\mu\text{g}/\text{mL}$ )**

Standard No	n-PFOS	Sm-PFOS (P5MHpS)	Sm <sub>2</sub> -PFOS (P55DMHxS)	PFHxS	PFBuS	Sb-PFOA (P5MHpA+ P55DMHxA)	All other analytes
Standard 1	0.015	0.01	0.005	0.005	0.004	0.0294	0.005
Standard 2	0.06	0.05	0.01	0.009	0.009	0.118	0.01
Standard 3	0.15	0.1	0.05	0.05	0.043	0.294	0.05
Standard 4	0.60	0.25	0.1	0.095	0.086	0.686	0.1
Standard 5	1.5	0.50	0.2	0.47	0.428	1.37	0.5
Standard 6	6.0	1.0	0.2	0.945	0.855	2.45	1.0
Standard 7	15.0	2.5	0.5	4.70	4.28	5.88	5.0
Standard 8	60.0	5.0	1.00	9.45	8.55	11.8	10.0
Standard 9	115.	10.0	2.50	18.9	17.1	24.5	20.0

**(2) Internal Standard Spiking Solution**

The internal standard spiking solution is prepared by dissolving appropriate amounts of 13C2-PFHxA, 13C5-PFHpA, 13C4-PFOA, 13C4PFOS, 18O2-PFHxS, 13C5-PFNA, 13C2-PFDeA, 13C2-PFDoA, and D3-MePFOSA-AcOH (4-6 ng/mL) in water/methanol (50/50). A 50 µL spike of this solution provides concentrations of 4-6 ng/mL in 50 µL serum. Spiking solutions are stored frozen in 2.0 mL aliquots in polypropylene cryogenic vials until use.

**(3) Mass-Spec Operational Check Standard**

The instrument test sample is prepared by spiking the reagent blank with all analytes to final concentrations of 0.3-0.5 ng /mL.

**(4) In-house Proficiency Testing (PT) Standards**

Appropriate aliquots of each stock standard are added to calf serum pools to produce 3 sets of in-house proficiency testing (PT) standards. The PT standards are mixed, aliquoted into polypropylene vials and frozen until needed. PT standards are characterized by at least 20 repeated analyses to determine the mean and standard deviation of the measurements.

**d. Materials**

- (1) HySphere C8-SE (7µM) cartridge (i-Chrome solutions, Plainsboro, NJ)
- (2) Chromolith® HighResolution RP-18e column (4.6 × 100 mm) (Merck KGaA, Germany).
- (3) Chromolith® HighResolution RP-18e Guard column (5 X 4.6 mm) (Merck KGaA, Germany).
- (4) Chromolith® HighResolution RP-18e column (4.6 × 25 mm) (Merck KGaA, Germany).
- (5) 750 µL polypropylene autosampler vials with polyethylene snap caps (National Scientific Company, Rockwood, TN).
- (6) Tip ejector variable volume micropipettes (Wheaton, Millville, NJ) and pipette tips (Rainin Instruments Co., Woburn, MA).
- (7) 5.0 mL and 2.0 mL polypropylene cryovials (National Scientific Company, Rockwood, TN).
- (8) Assorted glass and polypropylene labware.

**e. Equipment**

- (1) Symbiosys extractor equipped with an Alias autosampler run by the SparkLink software program (Spark Holland Inc. dba iChrom Solutions, Plainsboro, NJ).
- (2) Agilent 1200 binary pump and degasser (Agilent Technologies).
- (3) Applied Biosystems ABI 5500 or ABI 6500 Qtrap mass spectrometer (Applied Biosystems, Foster City, CA).
- (4) Sartorius Genius Series ME models Electronic Analytical & Semi – microbalances (Sartorius AG, Goettingen, Germany).
- (5) Sartorius top – loading balance (Sartorius AG, Goettingen, Germany).
- (6) pH meter (AB 15 pH Meter, Fisher Scientific).
- (7) Vortex mixer (Type 16700, Barnstead International, Dubuque, Iowa).

**f. Instrumentation****(1) Automated SPE**

Tubing diagram for the Symbiosis column switching system used in concurrent SPE/HPLC mode. (LCV: left clamp valve; DV-1: divert valve 1; DV-2: divert valve 2; RCV: right clamp valve).

The method uses both left and right cartridge clamps, the four switching valves, and the high pressure dispenser. The left clamp, the left clamp valve (LCV), and left divert valve (DV-1) are used for SPE separation while the right clamp, the right clamp valve (RCV) and right divert valve (DV-2) are used for the HPLC elution. The SPE run of each sample starts with the conditioning of a HySphere C8-SE (7 $\mu$ M) cartridge with HPLCgrade acetonitrile (2 mL) and 0.1 M formic acid (2 mL). Afterward, 500  $\mu$ L of the sample (containing 50  $\mu$ L serum) injected into the 1 mL sample loop is loaded onto the SPE column using 2 mL 0.1 M formic acid with 1 mL/min flow rate. Next, the SPE column is washed with 2 mL 90% 0.1 M formic acid/10% Acetonitrile. The time of the SPE cleanup (including injection time) is 10 min long. Before starting the clean up of the next sample, the cartridge containing the extracted analytes is transferred by a robotic gripper from the left clamp into the right clamp. Therefore, while the right clamp is used for analyte elution and HPLC-MS/MS acquisition, the left clamp could be used for the clean up of the next sample. Once, the SPE column is in the right clamp, the right clamp valve remains in bypass (1-2) position until the HPLC-MS/MS system becomes ready to begin acquisition.



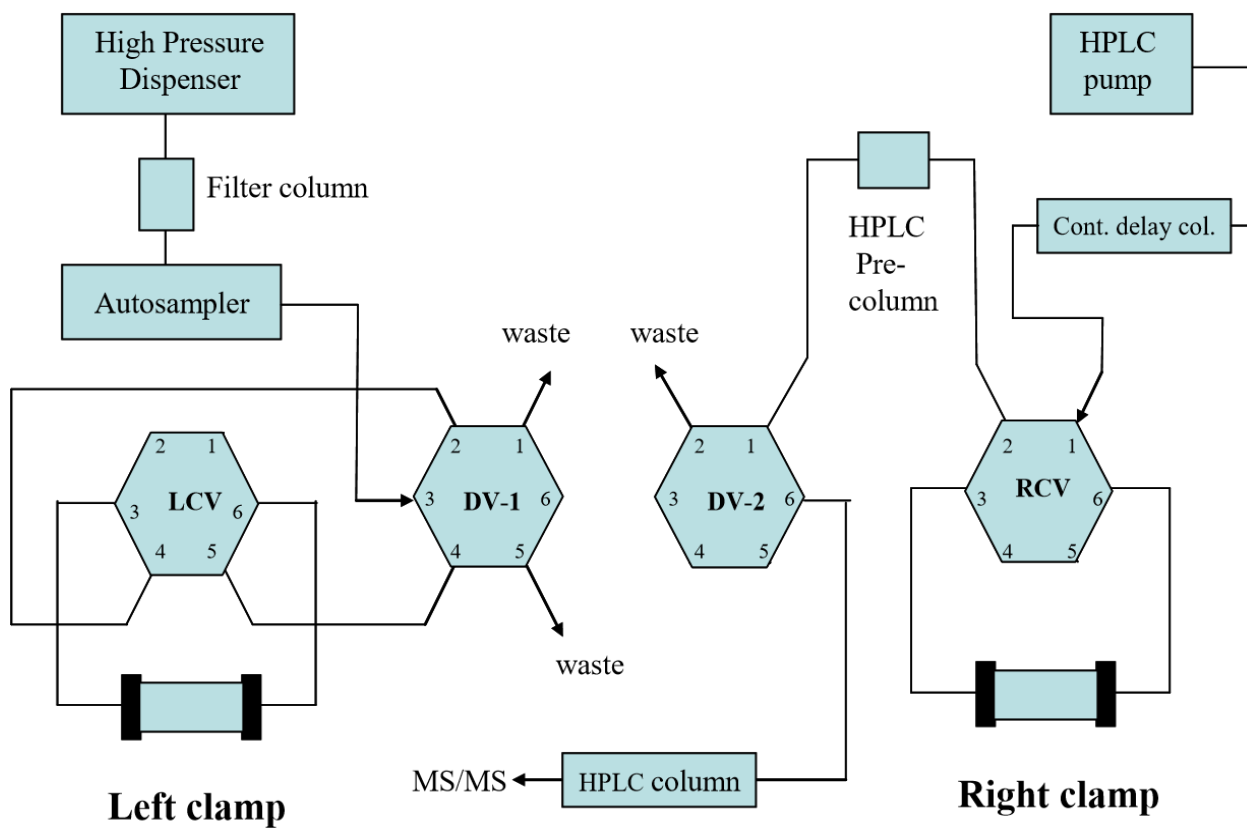

The Symbiosis system is used in concurrent SPE/HPLC mode controlled by the SparkLink software (Table 2).

**Table 2. Valve configurations used for concurrent SPE clean up and HPLC-MS/MS acquisition.**

Steps <sup>a</sup>	Method	LCV	DV-1	DV-2	RCV	Time (min)
1	Move cartridge from left clamp to right clamp	6-1	1-2	6-1	1-2	0.1
2	Load new cartridge into left clamp	6-1	1-2	6-1	1-2	0.2
3	Send contact closer signal to HPLC/MS/MS	6-1	1-2	6-1	1-2	0.1
4	Begin HPLC gradient elution by-pass HPLC column and MS/MS	6-1	1-2	1-2	6-1	3.0 <sup>b</sup>
5	Condition left cartridge (2 mL acetonitrile, 2 mL/min)	1-2	1-2	6-1	6-1	1.2
6	Equilibrate left cartridge (2 mL 0.1 M formic acid, 2 mL/min)	1-2	1-2	6-1	6-1	1.2
7	Load 500 µL sample on left cartridge (2 mL, 0.1 M formic acid, 1 mL/min)	1-2	1-2	6-1	6-1	4.4
8	Forward wash left cartridge (2 mL 90% 0.1 M formic acid/10% acetonitrile, 1 mL/min)	1-2	1-2	6-1	6-1	1.2
9	Return right cartridge to tray	6-1	1-2	6-1	1-2	0.1

<sup>a</sup> The method used for the first sample included only steps 2 and 5-8. The method used for the acquisition of the last sample included only steps 1, 3, 4, and 9.

<sup>b</sup> For the acquisition of the last sample duration of step 4 was 13 min.

## (2) HPLC configuration

At the beginning of the HPLC-MS/MS acquisition, the right clamp valve is turned into 6-1 position for the first 10 min of the HPLC gradient program to transfer the analytes from the SPE column to the HPLC column. At 10 min, the right clamp valve turns back to 1-2 position and the SPE column is returned to the cartridge tray while the HPLC gradient program continues. The HPLC pump is operated at a 1000 µL/min flow rate with 95% of 20 mM ammonium acetate (pH 4) and 5% of acetonitrile as mobile phase A and 100% acetonitrile as mobile phase B. The analytes are separated from each other and other extracted components on two Chromolith® HighResolution RP-18e columns (4.6 × 100 mm) preceded by a Chromolith® HighResolution RP-18e (5 X4.6 mm) guard column and a Chromolith® HighResolution RP-18e (4.6 × 25 mm) column. To delay the elution of the PFAS contaminants leaching out from Teflon parts of the HPLC pump, a 4.6 mm x 25 mm Chromolith® HighResolution RP-18e column is inserted between the HPLC pump and the right clamp valve. Because contaminants have to go through

twice the column length, their peaks elute 1 min after the main analytes bands without interfering with the measured concentration.

**Table 3. HPLC configuration**

Parameters	Setting
Mobile Phase A	95% 20 mM ammonium acetate, pH = 4/5% acetonitrile
Mobile Phase B	100% acetonitrile
Flow rate	1000 $\mu$ L/min

**Table 4. Mobile phase gradient**

Time (min)	0	1	2	8.5	8.51	12	12.1	13	13.2
Mobile phase B%	25	25	45	49	60	60	80	80	80
Flow rate (mL/min)	1.0	1.0	1.0	1.0	1.0	1.0	1.0	1.0	1.0
Time (min)	13.3	13.5	13.6	15.5	15.6	16.5	16.6	18	18.1
Mobile phase B%	80	95	95	95	95	95	25	25	25
Flow rate (mL/min)	1.5	1.5	1.8	1.8	2.0	2.0	1.5	1.5	1.0

### (3) Mass Spectrometer Configuration

Detection of the target analytes is conducted on the ABI 5500 or ABI 6500 Qtrap mass spectrometer in the negative ion Turbo Ion Spray (TIS) mode. The TIS ionization source is a variant of the electrospray source and is used to convert liquid phase ions into gas phase ions. We use laboratory-grade air heated turbo ion spray gas (GS1=50 and GS2=50) gas. The heated turbo ion spray gas temperature is set at 400 °C. The curtain and collision gas (nitrogen) settings are as follows: collision (medium), curtain gas (CUR=30 [ABI 5500], CUR=45 [ABI 6500]). Ionization parameters and collision cell parameters are optimized individually for each analyte (Table 5). Unit resolution is used for both Q1 and Q3 quadrupoles. The dwell time is 50 msec for all compounds.

**Table 5. Mass spectrometric parameters for measuring PFASs**

ion (m/z)	(M-H) <sup>-</sup> Precursor	Product ion (m/z)	DP (volts)	CE (volts)
Me-PFOA-AcOH	570	512	-45	-30
D <sub>3</sub> -Me-PFOA-AcOH(IS)	573	515	-45	-30
PFBuS-1	299	99	-70	-80
PFBuS-2 <sup>a</sup>	299	80	-70	-85
PFHxS-1	399	99	-70	-80
PFHxS-2 <sup>a</sup>	399	80	-70	-85
PFHxS- <sup>18</sup> O <sub>2</sub> -1 (IS) <sup>b</sup>	403	103	-70	-80
PFHxS- <sup>18</sup> O <sub>2</sub> -2 (IS) <sup>a</sup>	403	84	-70	-85
n-PFOS-1 <sup>a</sup>	499	80	-70	-90
n-PFOS-2	499	99	-70	-80
PFOS- <sup>13</sup> C <sub>4</sub> -1 (IS) <sup>c</sup>	503	80	-70	-85
PFOS- <sup>13</sup> C <sub>4</sub> -2 (IS)	503	99	-70	-85
Sm-PFOS	499	80	-70	-90
PFHpA	363	319	-25	-13
PFHpA- <sup>13</sup> C <sub>5</sub> (IS)	368	323	-25	-13
n-PFOA	413	369	-27	-14
Sb-PFOA	413	369	-27	-14
PFOA- <sup>13</sup> C <sub>4</sub> (IS) <sup>d</sup>	417	372	-30	-15
PFNA	463	419	-30	-13
PFNA- <sup>13</sup> C <sub>5</sub> (IS)	468	423	-30	-13
PFDeA	513	469	-30	-15
PFDeA- <sup>13</sup> C <sub>2</sub> (IS)	515	470	-30	-15
PFUA	563	519	-30	-17
PFUA - <sup>13</sup> C <sub>2</sub> (IS)	565	520	-30	-17
PFDoA	613	569	-30	-18
PFDoA- <sup>13</sup> C <sub>2</sub> (IS)	615	570	-45	-15

<sup>a</sup> used only as confirmation ion

<sup>b</sup> PFHxS-<sup>18</sup>O<sub>2</sub>-1 was used as IS for PFBuS.

<sup>c</sup> PFOA-<sup>13</sup>C<sub>4</sub> was used as IS for both n-PFOS, Sm-PFOS, and Sm<sub>2</sub>-PFOS.

<sup>d</sup> PFOA-<sup>13</sup>C<sub>4</sub> was used as IS for both n-PFOA and Sb-PFOA.

## **7. Calibration and Calibration-Verification Procedures**

### **a. Calibration Curve**

Nine-point calibration curves are normally constructed with each quantitative run from the analyte area ratios (i.e., analyte area/internal standard area) obtained from extracted standards in calf serum. A linear regression analysis (weighted by  $1/x$ ) of the area ratio versus standard concentration is performed. The area of the Q1 ion for each analyte is used for quantification (for PFOS we use Q2). Correlation coefficients are generally greater than 0.97. Samples with values exceeding the highest point in the calibration curve are reanalyzed using less serum.

### **b. Mass Spectrometer Calibration**

The ABI 5500 or ABI 6500 Qtrap mass spectrometer is calibrated and tuned at least once per year using a polypropylene glycol (PPG) solution according to the instructions contained in the operator's manual. The instrument sensitivity is checked periodically by injecting the Instrument Test sample.

### **c. Calibration Verification**

- (1) Calibration verification is not required by the manufacturer. However, it should be performed after any substantive changes in the method or instrumentation (e.g., new internal standard, change in instrumentation), which may lead to changes in instrument response, have occurred.
- (2) Calibration verification must be performed at least once every 6 months.
- (3) All calibration verification runs and results shall be appropriately documented.
- (4) According to updated CLIA regulations from 2003, the requirement for calibration verification is met if the test system's calibration procedure includes three or more levels of calibration material, and includes a low, mid, and high value, and is performed at least once every six months (<http://www.cms.gov/Regulations-and-Guidance/Legislation/CLIA/downloads/6065bk.pdf>).
- (5) All of the conditions above are met with the calibration procedures for this method. Therefore, no additional calibration verification is required by CLIA.

### **d. Proficiency Testing (PT)**

- (1) Three pools of PT samples, which encompass the entire linear range of the method, are prepared in-house as described in the standard preparation section. Characterization of PT materials requires at least 20 separate determinations. Once the PT pools are characterized, the mean concentration and standard deviation of the PT materials are forwarded to a DLS representative (PT administrator) responsible for executing the PT program. These PT samples are blind-coded by the PT administrator and returned to the laboratory staff for storage.
- (2) Proficiency testing should be performed a minimum of once per 6 months. When proficiency testing is required, the laboratory supervisor or his/her designee will notify the PT administrator, and the PT administrator will randomly select five PT materials for analysis. Following analysis, the results will be forwarded directly to the PT administrator for evaluation. A passing score is obtained if at least four of the five samples fall within the prescribed limits established by the PT administrator. The PT administrator will notify the laboratory supervisor and/or his/her designee of the PT results (i.e., pass/fail).
- (3) All proficiency results shall be appropriately documented.
- (4) In addition to the in-house PT program, since 2005 we have successfully participated in the international round-robin program organized by Intercal (Sweden) and RIVO (The Netherlands) when it is conducted for human serum/plasma 22,23.

- (5) Also, since 2006, at least once per year, we participate in the ongoing German External Quality Assessment Scheme (G-EQUAS) for PFOS and PFOA in serum, organized and managed by the Institute and Outpatient clinic for Occupational, Social and Environmental Medicine of the University of Erlangen-Nuremberg (Erlangen, Germany). The design, evaluation and certification of G-EQUAS are based on the guidelines of the German Federal Medical Council.
- (6) Since 2011, three times a year we also participate in the ongoing Arctic Monitoring and Assessment Program (AMAP) Ring Test for several PFASs in human serum, conducted by the Institut National de Santé Publique du Québec (INSP) in Canada.
- (7) Analytes nomenclature and structures:

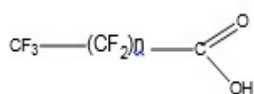

n=5 PFHpA  
 n=6 n-PEQA  
 n=7 PFNA  
 n=8 PFDpA  
 n=9 PFUA  
 n=10 PFDpA

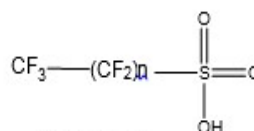

n=3 PFBuS  
 n=5 PFHxS  
 n=7 n-PEOS

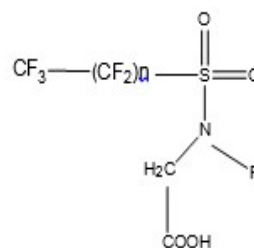

n=7, R=Me, Me-PFOA-AcOH

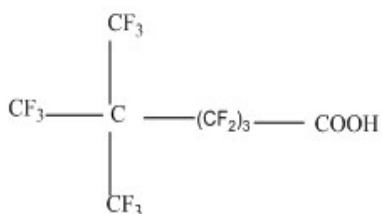

perfluoro-5,5-dimethylhexanoic Acid

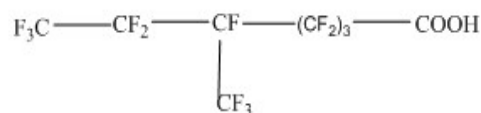

perfluoro-5-methylheptanoic Acid

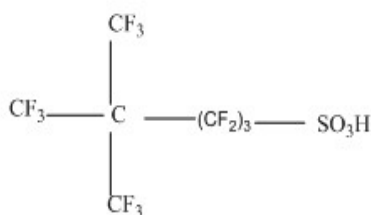

perfluoro-5,5-dimethylhexane sulfonic acid

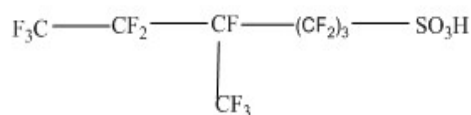

perfluoro-5-methylheptane sulfonic acid

## 8. Operating Procedures, Calculations, and Interpretation of Results

### a. Sample Preparation

#### (1) Unknown, QC, Blank, and Standard Preparation

- (a) Remove serum samples, working standard solutions and internal standard solution from the freezer, and let them thaw. Label polypropylene snap-cap autosampler vials with appropriate Sample Names. Aliquot 0.1 M formic acid (500  $\mu$ L for QCBs; 450  $\mu$ L for UNKs, QCs, serum blanks (SBs), and human serum blanks (HSBs); 400  $\mu$ L for STDs) into appropriate vials.
- (b) Dispense 50  $\mu$ L of internal standard into each polypropylene autosampler snap cap vials. In specific cases, the method can be performed using a smaller volume of matrix; the applied dilution factor must be noted appropriately.
- (c) Add 50  $\mu$ L of the appropriate native standard solution (S1-S9) into the polypropylene vials designated for standards.
- (d) Aliquot 50  $\mu$ L of UNKs, QCs, SBs and HSBs into the designated autosampler vials. For standards, aliquot 50  $\mu$ L of blank serum. Analysis may also be conducted with a smaller amount of serum; in these circumstances, the volume used must be noted appropriately throughout the analytical procedure.
- (e) Vortex all vials for at least 10 seconds to make sure all the internal standard and standard mixed into the sample.

#### (2) Automated SPE-HPLC-MS/MS Analysis Procedure

- (a) Put the Alias into load position. Initialize the high pressure dispenser (HPD) and the automated cartridge exchanger (ACE) unit.
- (b) Exchange the cartridge tray after every 500 samples.
- (c) Purge the solvent lines on the HPLC binary pump and equilibrate the HPLC column.
- (d) In the SparkLink software, go to RunTables and open and set up the batch table. For the first sample enter xx-method 1 which runs the injection and cleanup of the first sample. For the second and consecutive samples use xx-method 2 which initiates the HPLC/MS acquisition and runs the injection and cleanup of the next sample. For the last sample enter xxmethod 3 which initiates the HPLC/MS acquisition of the last sample. For injection volume, enter 500  $\mu$ L. Make sure the right vial positions are entered and there is no sequential duplication of cartridge numbers. The sample names and sample IDs do not matter, since they will not be part of the acquired data.
- (e) Go to Excel, open the text file containing the batch table created from Sample Login Table in the Microsoft Access database. This file should not require any editing. Save the table into the text file named import.txt into the Batch directory (overwrite). Remember to CLOSE THE FILE IN EXCEL!!!!



- (f) Go to Analyst and import the import.txt file (Sample pull down, go to gray header and click RMB, then Import From/File, select Alias autosampler). Make sure that the proper Acquisition Method and Quantitation Method are entered. Then, submit the batch (highlight and/or click Submit, go to View Queue, and click Start Sample). All samples on the Queue Manager should be in "waiting".
- (g) Start the batch table in SparkLink. From this on everything should run automatically.

## **b. Analysis**

### **(1) Check out the LC/MS interface**

- (a) If the instrument is in ready mode, wait until the interface cools down. When the interface is cool enough, take out the capillary from the MS interface. Rinse the capillary with MeOH, sonicate in MeOH for 20 min if necessary. Periodically, take off the interface housing, and wipe out the skimmer plate.
- (b) Open the rough pump cabinet, check for oil leaks and unusual noise. Report anything unusual.

### **(2) Check out the LC system**

After the column has been conditioned, click on the Equilibrate icon, select the current method, and let the system equilibrate for approximately 30 minutes. Run the Instrument Check sample by opening the batch file named Instrument\_test.dab. Change the date in the Sample Name field. Make sure the proper Acquisition Method and Vial Position are entered, and submit the batch. The file should be saved into the Instrument\_test.wiff file. Open the chromatogram and compare the intensities and peak shape to those obtained a day and a week before. If peaks appear distorted (tailing peaks, broad peaks, etc.) change the column and submit the Instrument Check sample again. If the absolute intensity is too low (peak intensity should not be <70% less intense than before) check with the laboratory supervisor or his/her designee.

### **(3) Check out the SPE system**

- (a) In SparkLink, put the Triathlon autosampler into load position. Initialize the high pressure dispenser (HPD) and the automated cartridge exchanger (ACE) unit.
- (b) Exchange the cartridge tray as needed (generally after approximately 500 samples).
- (c) Make sure that the MS remote cable is connected ACE unit.

### **(4) Building batch files**

- (a) In the SparkLink software, go to RunTables and open and set up the batch table. For the first sample enter xx-method 1 which runs the injection and cleanup of the first sample. For the second and consecutive samples use xx-method 2 which initiates the HPLC/MS acquisition and runs the injection and cleanup of the next sample. For the last sample enter xx-method 3 which initiates the HPLC/MS acquisition of the last sample. For injection volume, enter 500  $\mu$ L. Make sure that the proper vial positions are entered

and there is no sequential duplication of cartridge numbers. The sample names and sample IDs do not matter, since they will not be part of the acquired data.

- (b) In the Analyst software, open a new the subproject folder for each new run. The subproject should have the same YYYY-MMDD name as the unknowns it includes. Each subproject should have separate Acquisition Methods, Quantitation Methods, Batch, Data, and Results directories. Copy the latest Acquisition Method and Quantitation Method from the previous subfolder.
- (c) From Excel, open the text file containing the batch table created from the Access database using Microsoft Access. This file should not require any editing. Save the table into the text file named import.txt into the Batch directory (overwrite). Remember to CLOSE THE FILE IN EXCEL!!!! Go to Analyst, open a new batch table and import the import.txt file (Sample pull down, go to gray header and click RMB, then Import From/File, select Alias autosampler).
- (d) Make sure that the proper Acquisition Method and Quantitation
- (e) Method are entered. Although the vial positions entered in Analyst will not be used they should agree with the vial positions used on the Triathlon autosampler.

#### **(5) Starting the SPE-HPLC-MS/MS run**

- a) Start the batch table in **SparkLink**.
- b) Submit the batch table in Analyst (highlight and/or click Submit, go to View Queue, and click Start Sample). From this on everything should run automatically. After the SPE cleanup of the first sample, each N+1 sample in the SparkLink batch table will correspond with sample N in the Analyst batch table.

### **c. Processing data**

#### **(1) Quantification**

All raw data files are analyzed using the Quantitation Wizard application in the Analyst software, which allows both automatic and manual peak selection and area integration. The area values and retention times are exported into a tab delimited text file and imported into the Access database with the name YYYY-MMDD.txt.

#### **(2) Importing Data into the Database**

The tab-delimited file is read into the Access database. No prior editing is required.

#### **(3) Statistical Analysis and Interpretation of Data**

Data are exported from the Access database to a fixed ASCII text file and imported into SAS. SAS programs for standard curve generation, QC analysis, blank analysis, limit of detection determination, unknown calculations, and data distribution have been created and may be executed in SAS when this information is needed.

**d. Replacement and periodic maintenance of key components****(1) ABI 5500 or ABI 6500 Qtrap Mass Spectrometer**

Preventative maintenance is done by a qualified engineer at least once a year. In addition, to ensure proper performance of the system, a periodic maintenance of the system may be required.

- a) When a partial blockage of the vacuum is suspected, the orifice is probed with a syringe-cleaning wire.
- b) Cleaning of the spray shield and the entrance end of the heated capillary is performed weekly as described in the Sciex ABI 5500 or ABI 6500 Qtrap Hardware Manual. First, wash with a solution of water: methanol (1:1) and then, with 100% methanol. Wipe the area using flake free paper wipes.
- c) The pump oil is changed approximately every six months as part of the periodic maintenance of the system.

**(2) Agilent 1200 HPLC**

Preventative maintenance is done by a qualified engineer at least once a year. Additional maintenance may be necessary if there is a general decrease in instrument performance (see below). In general, performance maintenance procedures are performed after detecting a decrease in the system performance (sensitivity and/or S/N ratio) without any other apparent technical reasons.

- a) The HPLC column is replaced when analyte resolution decreases. Once the analyte peaks start tailing, the HPLC column should be replaced.
- b) If high pressure (>250 bar) error messages are observed, the purge valve frit, the guard column, analytical column frit, HPLC lines, needle seat, or injector components may need to be replaced. See also section 8b.
- c) Reestablishment of performance and calibration. Every time the system is disturbed for cleaning or maintenance, a mass spec operational check standard is analyzed to assess the HPLC and MS performance. For the mass spectrometer, a retune of the system may or may not be necessary. If the instrument does not pass this test, then the instrument is retuned using PPG as described previously.

**(3) Spark system**

Preventative maintenance is done by a qualified engineer at least once a year. Additional maintenance may be necessary if there is a general decrease in instrument performance.

If the SparkLink error "HPD 1 high pressure problem" occurs, check the SPE lines and HPD 6 port valve. The HPD valve stator and/or rotor may need to be replaced.

The instrumentation used is serviced according to the manufacturer's guidance included in the instrument manuals or based on the recommendation of experienced analysts/operators after following appropriate procedures to determine that the instrument performs adequately for the intended purposes of the method.

## 9. Reportable Range of Results

The linear range of the standard calibration curves and the method limit of detection (LOD) determine the reportable range of results. The reportable range must be within the range of the calibration curves. However, samples with concentrations exceeding the highest reportable limit may be diluted, re-extracted, and reanalyzed so that the measured value will be within the range of the calibration.

If a sample needs more than 100 times dilution (which would require using less than 1  $\mu\text{L}$  of specimen) the dilution can be performed in at least two steps. For example, first, at least 10  $\mu\text{L}$  specimen is diluted up to 1 mL with water in a 2 mL Eppendorf tube (or equivalent), then a second dilution is performed by aliquoting the appropriate fraction of the dilute into an autosampler vial and adding 100  $\mu\text{L}$  blank calf serum. With very concentrated specimens it may be difficult to estimate the dilution that is necessary, and the measured value may be higher than the highest calibration point even after the dilution.

Formula to calculate the dilution factor to be entered into the Analyst batch file:

$$D = (1000 / V_{1\text{st}}) \times (200 / V_{2\text{nd}}).$$

Formula to calculate the volume of specimen to be entered into the Access database:

$$V = V_{1\text{st}} \times (V_{2\text{nd}} / 1000)$$

Where  $V_{1\text{st}}$  is the volume of the aliquot taken from the original specimen and  $V_{2\text{nd}}$  is the volume of the dilute measured into the autosampler vial.

### 1) Analytical Sensitivity

The limits of detection (LOD) for each analyte are listed in **Table 6**.

### 2) Analytical Specificity

This is a highly selective method that requires that the PFAS: 1) elute at a specific retention time; 2) have precursor ions with specific mass/charge ratios; and 3) have specific product ions formed from the precursor ion with specific mass/charge ratios.

### 3) Linearity Limits

The calibration curve is linear for all analytes (generally  $R^2 > 0.95$ ). The limit on the linearity is determined by the highest standard analyzed in the method. Due to the wide variation of PFASs levels in humans, we set our highest standard near the high end of the linear range (**Table 6**). Unknown samples whose concentrations exceed the highest standard concentration must be re-extracted using a smaller aliquot. The low end of the linear range is limited by the method LOD. Concentrations below the method LOD (or the concentration of the lowest standard in the calibration curve) are reported as non-detectable.

**Table 6. Linear range (lowest – highest standard concentration) and LOD for each PFAS measured in serum.**

Analyte	LOD	Linear range (ng/mL)
Me-PFOSA-AcOH	0.1	0.005-20
PFBuS	0.1	0.004-17.1
PFHxS	0.1	0.005-18.9
n-PFOS	0.1	0.015-115
Sm-PFOS	0.1	0.01-10
PFHpA	0.1	0.01-20
n-PFOA	0.1	0.01-20
Sb-PFOA	0.1	0.029-24.5
PFNA	0.1	0.01-20
PFDeA	0.1	0.01-20
PFUA	0.1	0.01-20
PFDoA	0.1	0.01-20

#### 4) Accuracy

The accuracy of the method is determined by enriching serum samples with known concentrations of PFASs and comparing the calculated and expected concentrations. To examine their consistency over the range of levels encountered in serum, the measurements are taken at 3 different concentrations, namely using standards near 3\*LOD, middle level (~1.0 ng/mL, except n-PFOS (6 ng/mL), Sm-PFOS and Sm2-PFOS (0.5 ng/mL), and Sb-PFOA (0.7 ng/mL)), and high level (~10.0 ng/mL, except n-PFOS (60 ng/mL), Sm-PFOS and Sm2-PFOS (1.0 ng/mL), and Sb-PFOA (2.5 ng/mL)). The accuracy is calculated from 5 independent measurements (**Table 7**).

Table 7. Spiked recoveries of extracted standards in serum

Analyte	Accuracy (%) at ~3*LOD/middle/high		
Me-PFOSA-AcOH	105±20	93±5	101±3
PFBuS	113±25	105±19	110±12
PFHxS	106±12	98±5	98±6
n-PFOS	110±14	99.7±6	97.0±2
Sm-PFOS	105±23	92±4	90±4
PFHpA	115±12	110±11	103±10
n-PFOA	92±14	105±5	101±2
Sb-PFOA	112±15	106±8	102±5
PFNA	95±13	103±7	102±3
PFDeA	103±13	96±6	98±4
PFUA	92±17	102±3	101±3
PFDoA	110±22	96±10	101±3

## 5) Precision

The precision of this method is reflected in the variance of two quality control (QC) pools over a period of three weeks. The coefficient of variation (CV) of repeated measurements of these QC pools, which reflects both inter and intra-day variations, is used to estimate precision (**Table 8**).

Table 8. Mean QC concentrations (ng/mL) and CV%

Analyte	VQC	CV%	QCH	CV%
Me-PFOSA-AcOH	0.4	14.3	6.5	10.5
PFBuS	0.4	18.5	6.7	15.7
PFHxS	0.4	9.3	6.3	7.0
n-PFOS	1.0	10.6	15.8	9.8
Sm-PFOS	0.4	10.5	2.3	10.3
PFHpA	0.5	6.5	6.3	9.4
n-PFOA	0.4	13.6	7.4	12.0
Sb-PFOA	0.8	15.5	6.5	11.0
PFNA	0.4	10.6	8.1	9.4
PFDeA	0.5	10.9	6.3	9.7
PFUA	0.5	12.5	6.4	9.7
PFDoA	0.5	20.0	6.4	9.1

## 10. Quality Control (QC) Procedures

### a. Individual Samples (i.e., standards, unknown samples, serum blanks, and QC materials) QC procedures

- (1) For each analyte, the relative retention time (RT) (ratio of RT analyte and RTIS) of standards, unknowns, and QCs should be checked. If the relative RT falls outside the range, check the integration to make sure the analyte or IS peak was properly picked up.
- (2) For each analyte, the IS area counts should meet minimum area count requirements. Low IS area counts suggest a) strong ion suppression from the matrix, or b) missing of IS. Depending on the findings, either re-extract the sample as usual or re-extract the sample after dilution.
- (3) For each analyte, the calculated concentration of the calf serum blanks (SB) should be less than three times the LOD. Using the current method, all standards, blanks and unknown samples are prepared following the same procedure, thus background blank values (reflected in the intercept of the calibration curve) are automatically subtracted from the concentrations of unknown samples. If background levels are above the threshold above, the reagents used for sample preparation and (or) mobile phases need to be checked for potential contamination.
- (4) For each analyte, if the concentration in an unknown sample is above the highest calibration standard, the sample needs to be re-extracted with a smaller volume of serum.

### b. Quality control of the QC materials

#### (1) QC Materials

The QC materials were prepared in bulk from calf serum (Gibco, Grand Island, NY). The target ranges for the pools were set to encompass the expected concentration ranges in human populations.

#### (2) Preparation of QC Pools

The calf serum purchased was pooled and the QC pools were mixed uniformly, divided into four subpools and stored frozen. One subpool was used as a blank QC and to prepare the calibration standards, and the other three were enriched with PFASs as needed to afford very low concentration (VQC, ~0.3-1.0 ng/mL), low concentration (QCL, ~2.0 ng/mL) and high concentration (QCH, ~0.8-15.8 ng/mL) subpools. The QC pools were characterized to define the mean and the 95% and 99% control limits of PFASs concentrations by a minimum of 30 repeated measurements in a three week period. QC materials reextracted and analyzed after the initial characterization showed that the PFASs remained stable frozen for at least 3 months<sup>21</sup>.

#### 3) Characterization of QC Materials

For characterization, a minimum of 30 runs of QCL and QCH were measured over 1 month. In each run, one pair of QCL and QCH materials were analyzed

and averaged. Using the pair average value from the 30 runs, the mean, and upper and lower 99% and 95% control limits were established.

QC samples are analyzed along with unknown samples to monitor for accuracy and precision throughout the analysis batch. Maximum 50 unknown samples are run with randomly placed 2 QCL, 2 QCH, and 2 reagent blank samples. The concentrations of the two QCL and two QCH in each batch are averaged to obtain one average measurement of QCL and QCH.

#### 4) Final evaluation of Quality Control Results

Standard criteria for run rejection based on statistical probabilities are used to declare a run either in-control or out-of-control<sup>24</sup>.

**QC rules for: Analytical run with 1 QC pool per run** (must also include a blank QC specimen):

##### **One QC pool per run with one QC result per pool**

- 1) If QC run result is within 2Si limits, then accept the run.
- 2) If QC run result is outside a 2Si limit - reject run if:
  - a) Extreme Outlier – Run result is beyond the characterization mean +/- 4Si
  - b) 1 3S Rule - Run result is outside a 3Si limit
  - c) 2 2S Rule - Current and previous run results are outside the same 2Si limit
  - d) 10 X-bar Rule – Current and previous 9 run results are on same side of the characterization mean
  - e) R 4S Rule – The current and the previous run results differ by more than 4Si. Note: Since runs have a single result per pool and only 1 pool, the R 4S rule is applied across runs only.

##### **One QC pool per run with two or more QC results per pool**

- 1) If QC run mean is within 2Sm limits and individual results are within 2Si limits, then accept the run.
- 2) If QC run mean is outside a 2Sm limit - reject run if:
  - a) Extreme Outlier – Run mean is beyond the characterization mean +/- 4Sm
  - b) 3S Rule - Run mean is outside a 3Sm limit
  - c) 2 2S Rule – Current and previous run means are outside the same 2Sm limit
  - d) 10 X-bar Rule – Current and previous 9 run means are on same side of the characterization mean
- 3) If one of the two QC individual results is outside a 2Si limit - reject run if:
  - a) R 4S Rule – Within-run range for the current run and the previous run exceeds 4Sw (i.e., 95% range limit)



Abbreviations:

$S_i$  = Standard deviation of individual results (the limits are not shown on the chart unless run results are actually single measurements).

$S_m$  = Standard deviation of the run means (the limits are shown on the chart).  $S_w$  = Within-run standard deviation (the limits are not shown on the chart).

**QC rules for: Analytical run with 2 QC pools per run:**

**Two QC pools per run with one QC result per pool**

- 1) If both QC run results are within  $2S_i$  limits, then accept the run.
- 2) If 1 of the 2 QC run results is outside a  $2S_i$  limit - reject run if:
  - a) Extreme Outlier – Run result is beyond the characterization mean  $\pm 4S_i$
  - b) 3S Rule - Run result is outside a  $3S_i$  limit
  - c) 2S Rule - Both run results are outside the same  $2S_i$  limit
  - d) 10 X-bar Rule – Current and previous 9 run results are on same side of the characterization mean
  - e) R 4S Rule – Two consecutive standardized run results differ by more than  $4S_i$ . Note: Since runs have a single result per pool for 2 pools, comparison of results for the R 4S rule will be with the previous result within run or the last result of the previous run. Standardized results are used because different pools have different means.

**Two QC pools per run with two or more QC results per pool**

- 1) If both QC run means are within  $2S_m$  limits and individual results are within  $2S_i$  limits, then accept the run.
- 2) If 1 of the 2 QC run means is outside a  $2S_m$  limit - reject run if:
  - a) Extreme Outlier – Run mean is beyond the characterization mean  $\pm 4S_m$
  - b) 3S Rule - Run mean is outside a  $3S_m$  limit
  - c) 2S Rule - Both run means are outside the same  $2S_m$  limit
  - d) 10 X-bar Rule – Current and previous 9 run means are on same side of the characterization mean
- 3) If one of the 4 QC individual results is outside a  $2S_i$  limit - reject run if:
  - a) R 4S Rule – Within-run ranges for all pools in the same run exceed  $4S_w$  (i.e., 95% range limit). Note: Since runs have multiple results per pool for 2 pools, the R 4S rule is applied within runs only.

**QC rules for: Analytical run with 3 QC pools per run:**

**Three QC pools per run with one QC result per pool**

- 1) If all 3 QC run results are within  $2S_i$  limits, then accept the run.

- 2) If 1 of the 3 QC run results is outside a 2Si limit - reject run if:
- a) Extreme Outlier – Run result is beyond the characterization mean +/- 4Si
  - b) 3S Rule - Run result is outside a 3Si limit
  - c) 2S Rule - 2 or more of the 3 run results are outside the same 2Si limit
  - d) 10 X-bar Rule – Current and previous 9 run results are on same side of the characterization mean
  - e) R 4S Rule – Two consecutive standardized run results differ by more than 4Si. Note: Since runs have a single result per pool for 3 pools, comparison of results for the R 4S rule will be with the previous result within the current run or with the last result of the previous run. Standardized results are used because different pools have different means.

**Three QC pools per run with two or more QC results per pool**

- 1) If all 3 QC run means are within 2Sm limits and individual results are within 2Si limits, then accept the run.
- 2) If 1 of the 3 QC run means is outside a 2Sm limit - reject run if:
- a) Extreme Outlier – Run mean is beyond the characterization mean +/- 4Sm
  - b) 3S Rule - Run mean is outside a 3Sm limit
  - c) 2S Rule - 2 or more of the 3 run means are outside the same 2Sm limit
  - d) 10 X-bar Rule – Current and previous 9 run means are on same side of the characterization mean
- 3) If one of the QC individual results is outside a 2Si limit - reject run if:
- a) R 4S Rule - 2 or more of the within-run ranges in the same run exceed 4Sw (i.e., 95% range limit). Note: Since runs have multiple results per pool for 3 pools, the R 4S rule is applied within runs only.

**11. Remedial Action if Calibration or QC Systems Fail to Meet Acceptable Criteria**

If the QC systems or the calibrations failed to meet acceptable criteria, operations are suspended until the source or cause of failure is identified and corrected. If the source of failure is easily identifiable (e.g., failure of the mass spectrometer or a pipetting error), the problem is immediately corrected. Otherwise, fresh reagents are prepared and the mass spectrometer is cleaned. Before beginning another analytical run, several QC materials (in the case of QC failure) or calibration standards (in the case of calibration failure) are reanalyzed. After calibration or quality control has been reestablished, analytical runs may be resumed.

**12. Limitations of Method; Interfering Substances and Conditions**

Occasionally, the concentration of the PFASs in serum may be higher than the highest standard in the calibration curves, and 0.1 mL of sample may be too much to use. This is evident by the low recovery of the isotope-labeled standard after the SPE extraction. In this case, a smaller aliquot of serum can be used. Most likely, the LOD is not higher in this case because of the concentrated nature of the specimen.

### **13. Reference Ranges (Normal Values)**

Results (<http://www.cdc.gov/exposurereport>) from the National Health and Nutrition Examination Survey (NHANES) can be used as reference ranges for the general US population <sup>25</sup>.

### **14. Critical-Call Results (“Panic” Values)**

Critical call values have not been established for any PFAS concentrations.

### **15. Specimen Storage and Handling During Testing**

Specimens are stored in the laboratory frozen prior to analysis. Frozen samples are allowed to thaw completely at room temperature prior to the initiation of the analytical procedure.

### **16. Alternate Methods for Performing Test and Storing Specimens if Test System Fails**

Alternate procedures do not exist in-house for the measurement of PFASs. If the analytical system fails, storage of samples refrigerated is recommended until the system is operational again.

### **17. Test-Result Reporting System; Protocol for Reporting Critical Calls (If Applicable)**

- a. The Quality Control officer reviews each analytical run, identifies the quality control samples within each analytical run and determines whether the analytical run is performed under acceptable quality control conditions.
- b. The data from analytical runs of unknowns are initially reviewed by the laboratory supervisor.
- c. If the quality control data and results are acceptable the laboratory supervisor generates a memorandum to the Branch Chief reporting the results.
- d. These data are then sent to the person(s) that made the initial request.
- e. Final hard copies of correspondence are maintained in the office of the Branch Chief and with the quality control officer.

### **18. Transfer or Referral of Specimens; Procedures for Specimen Accountability and Tracking**

Standard record keeping systems (e.g., notebooks, sample logs, data files) should be employed to keep track of all specimens. One spreadsheet form with information for receiving/transferring specimens is kept in the laboratory. In this form, the samples received are logged in when received and when stored/transferred after analysis. For NHANES samples, the person receiving the specimens signs and dates the shipping manifests. The shipping manifests for NHANES and other samples are kept in a binder in the Laboratory.

---

*Use of trade names is for identification only and does not imply endorsement by the Public Health Service or the U.S. Department of Health and Human Services.*

**2013–2014 Summary Statistics and QC Chart for 2-(N-methyl-PFOSA) acetate (ng/mL)**

Lot	N	Start Date	End Date	Mean	Standard Deviation	Coefficient of Variation
HQC-122014	50	02JUL14	11MAR15	7.09100	0.48089	6.8
LQC-122014	50	02JUL14	11MAR15	1.69470	0.13635	8.0

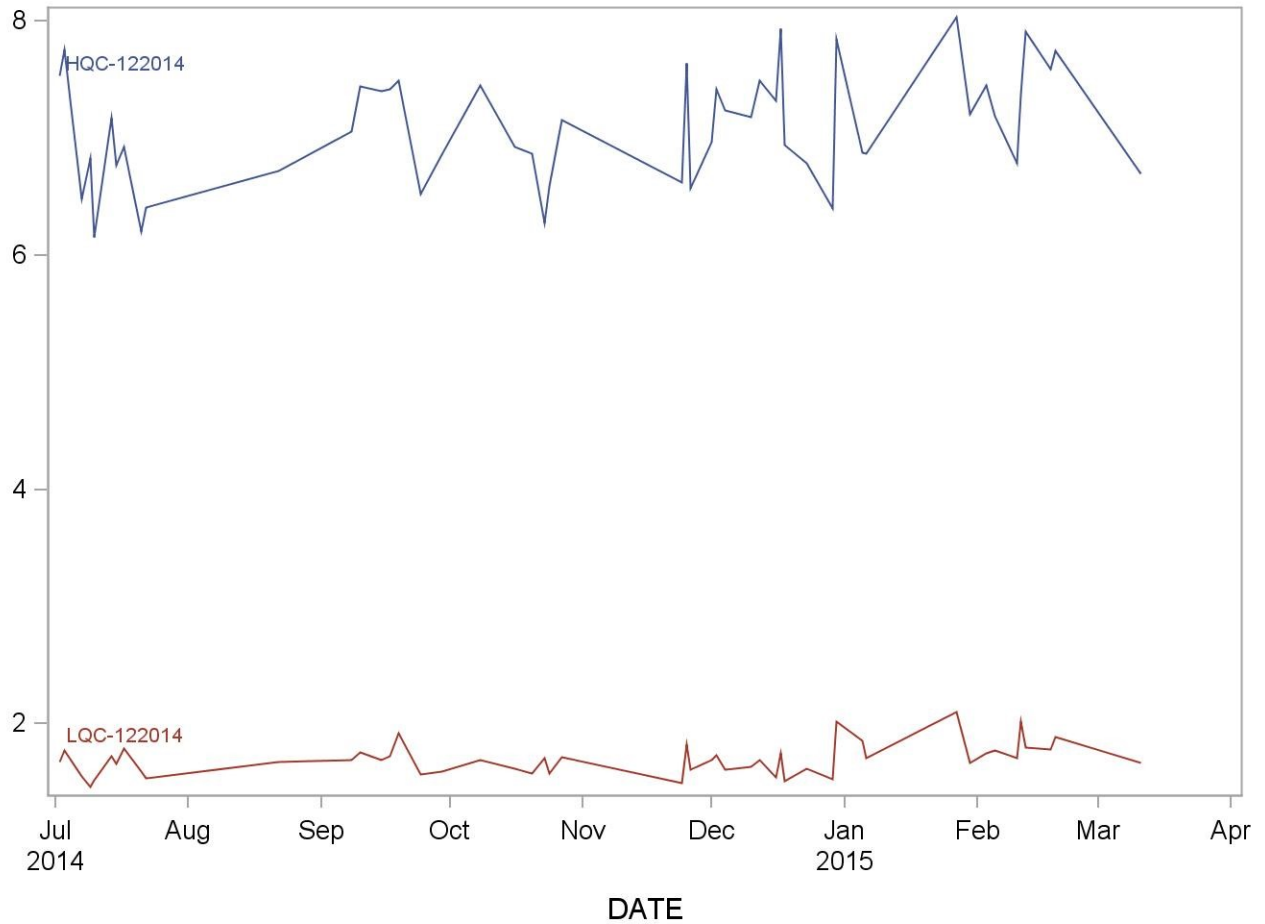

**2013–2014 Summary Statistics and QC Chart for Perfluorobutane sulfonic acid (ng/mL)**

Lot	N	Start Date	End Date	Mean	Standard Deviation	Coefficient of Variation
HQC-122014	50	02JUL14	11MAR15	5.629	0.548	9.7
LQC-122014	50	02JUL14	11MAR15	2.088	0.202	9.7

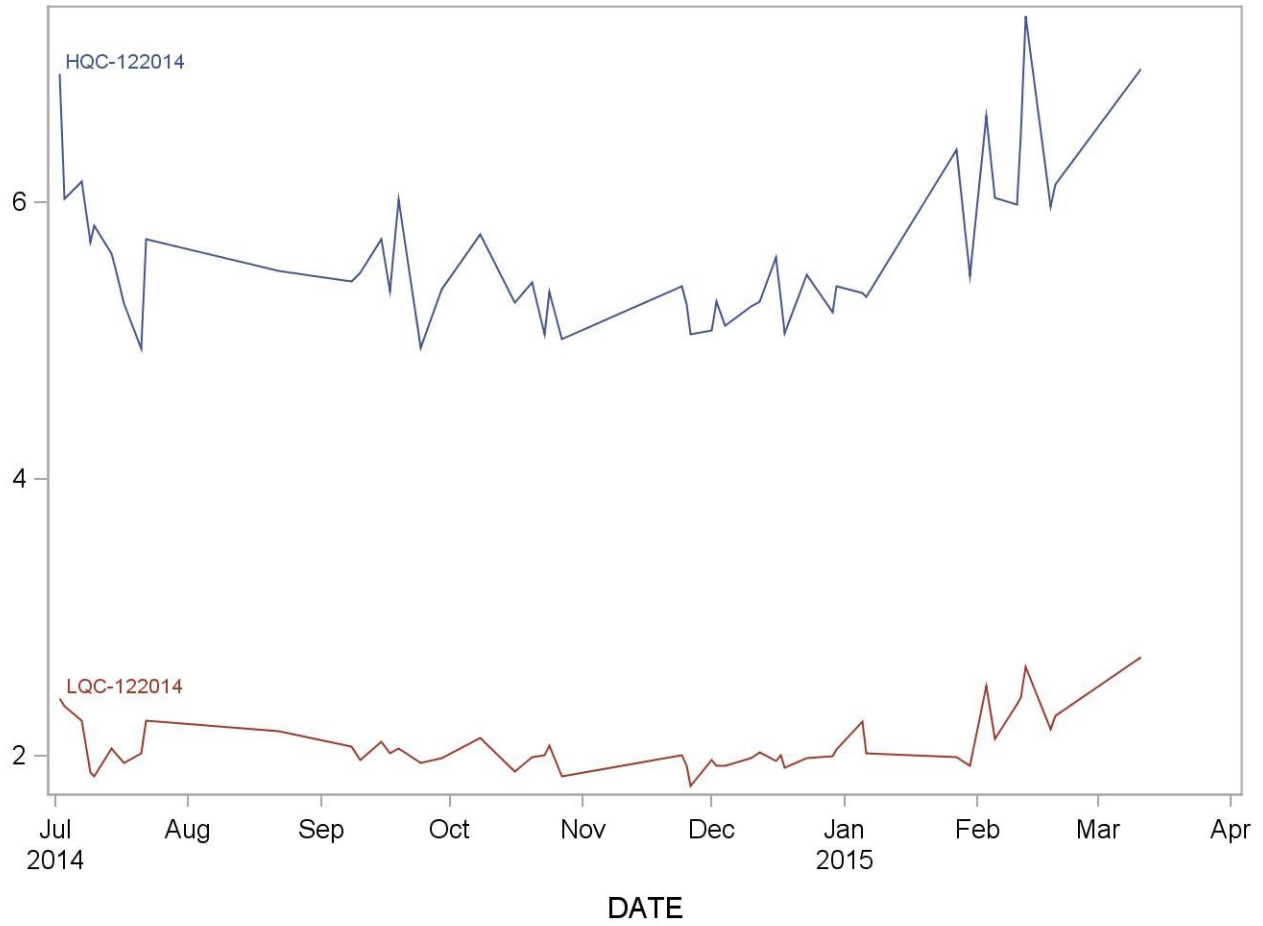

**2013–2014 Summary Statistics and QC Chart for Perfluorodecanoic acid (ng/mL)**

Lot	N	Start Date	End Date	Mean	Standard Deviation	Coefficient of Variation
HQC-122014	50	02JUL14	11MAR15	6.484	0.272	4.2
LQC-122014	50	02JUL14	11MAR15	2.461	0.129	5.3

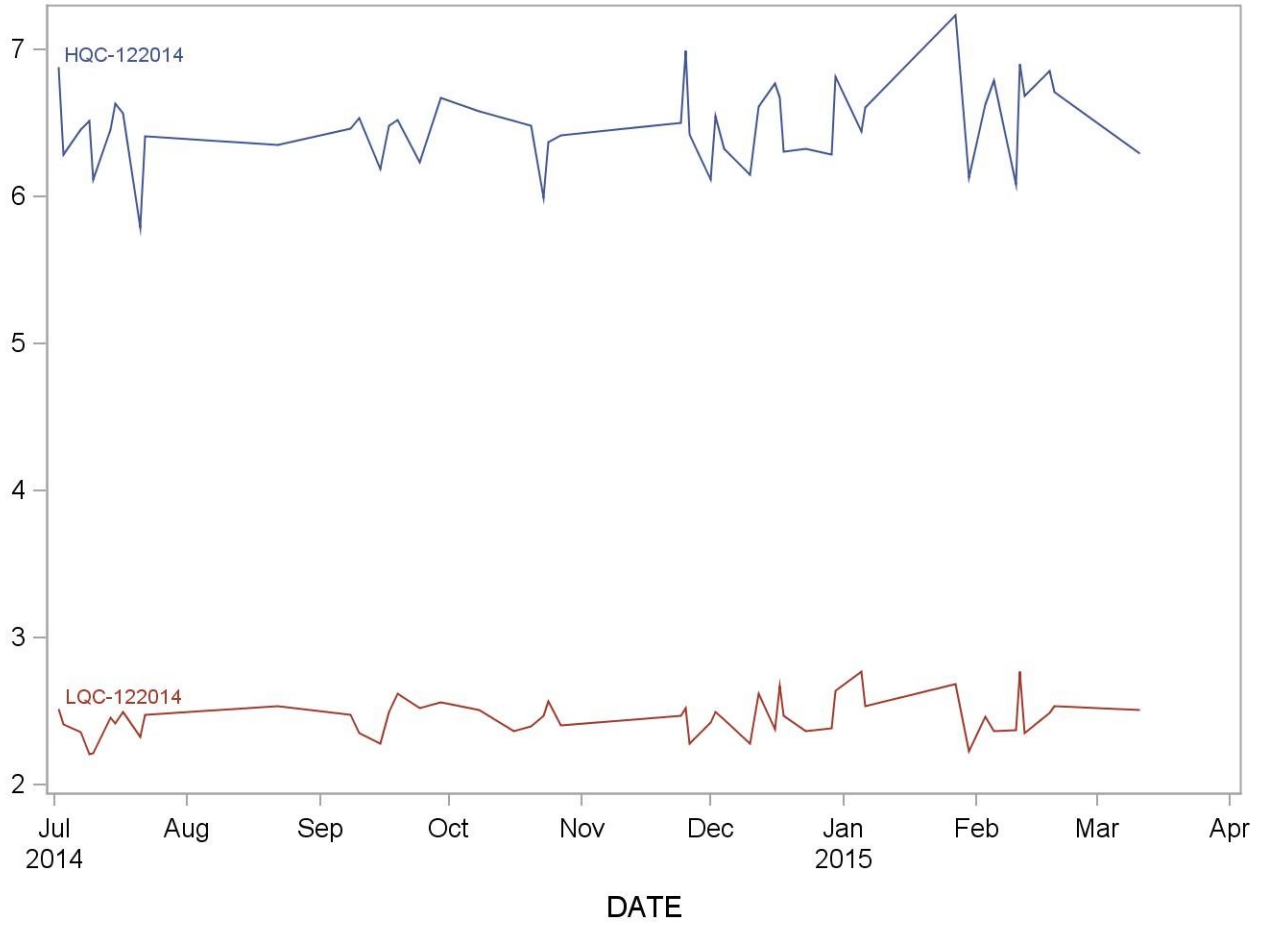

**2013–2014 Summary Statistics and QC Chart for Perfluorododecanoic acid (ng/mL)**

Lot	N	Start Date	End Date	Mean	Standard Deviation	Coefficient of Variation
HQC-122014	50	02JUL14	11MAR15	6.324	0.406	6.4
LQC-122014	50	02JUL14	11MAR15	2.390	0.263	11.0

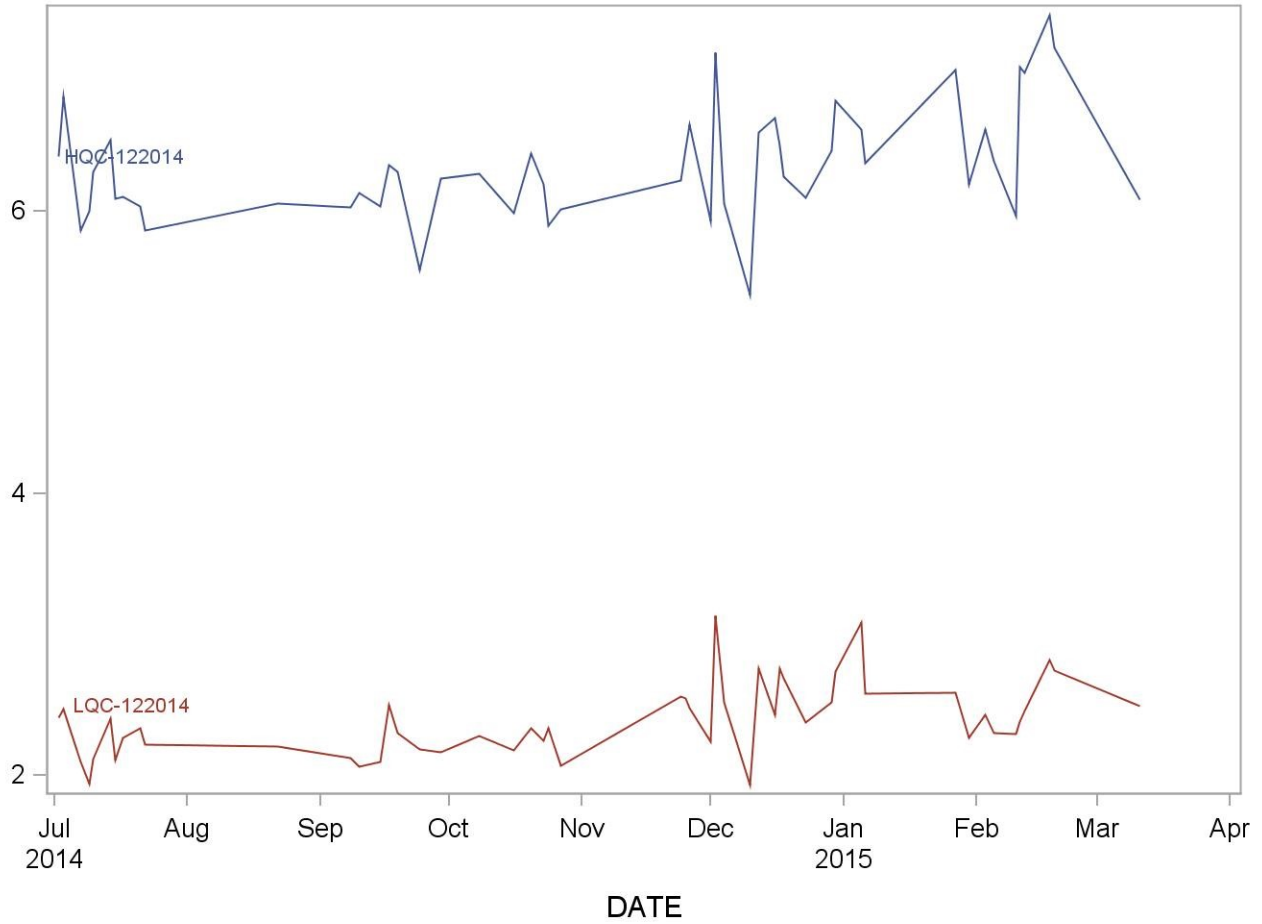

2013–2014 Summary Statistics and QC Chart for Perfluoroheptanoic acid (ng/mL)

Lot	N	Start Date	End Date	Mean	Standard Deviation	Coefficient of Variation
HQC-122014	50	02JUL14	11MAR15	6.458	0.328	5.1
LQC-122014	50	02JUL14	11MAR15	2.429	0.144	5.9

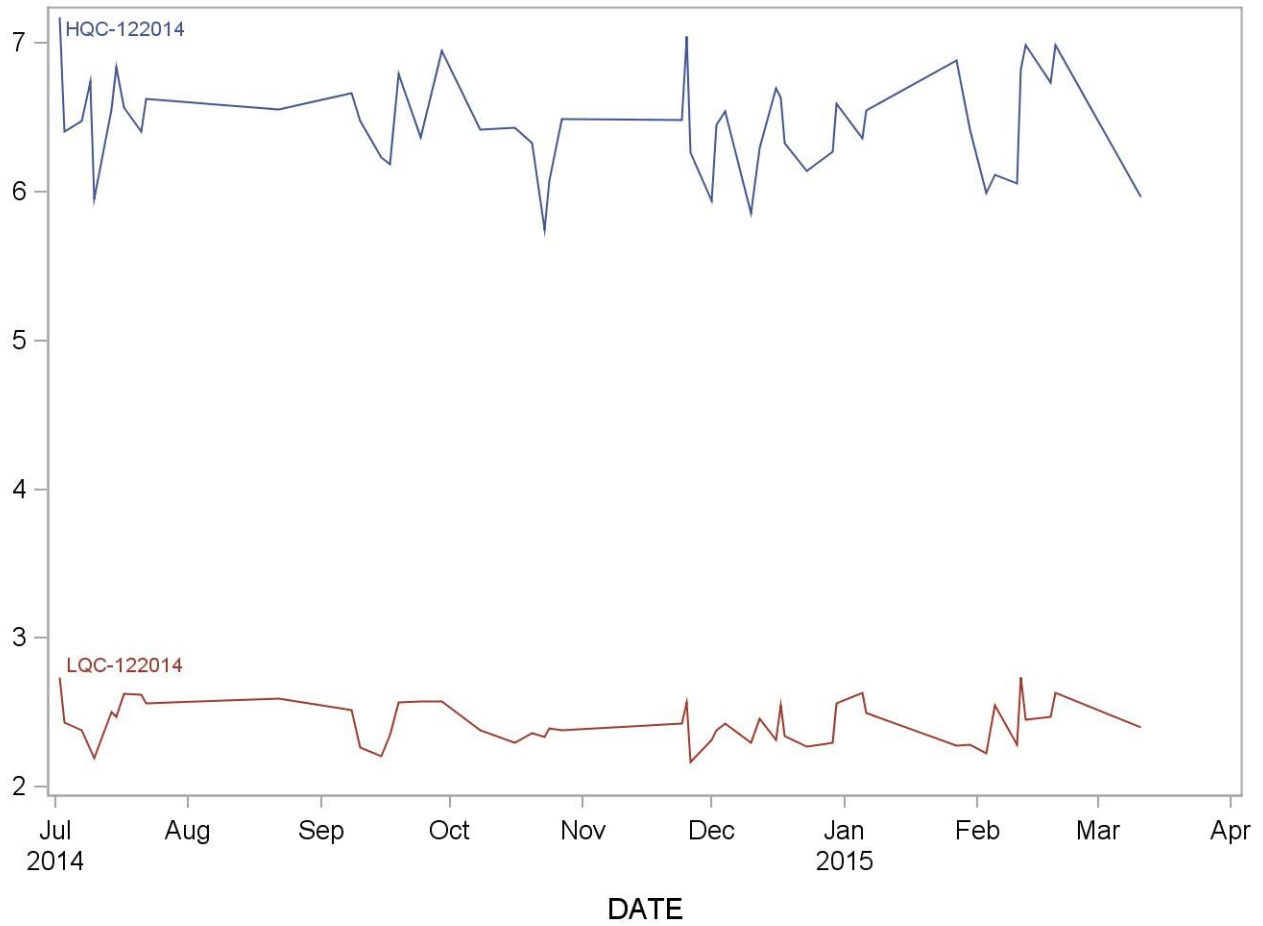



**2013–2014 Summary Statistics and QC Chart for Perfluorohexane sulfonic acid (ng/mL)**

Lot	N	Start Date	End Date	Mean	Standard Deviation	Coefficient of Variation
HQC-122014	50	02JUL14	11MAR15	6.105	0.243	4.0
LQC-122014	50	02JUL14	11MAR15	2.291	0.114	5.0

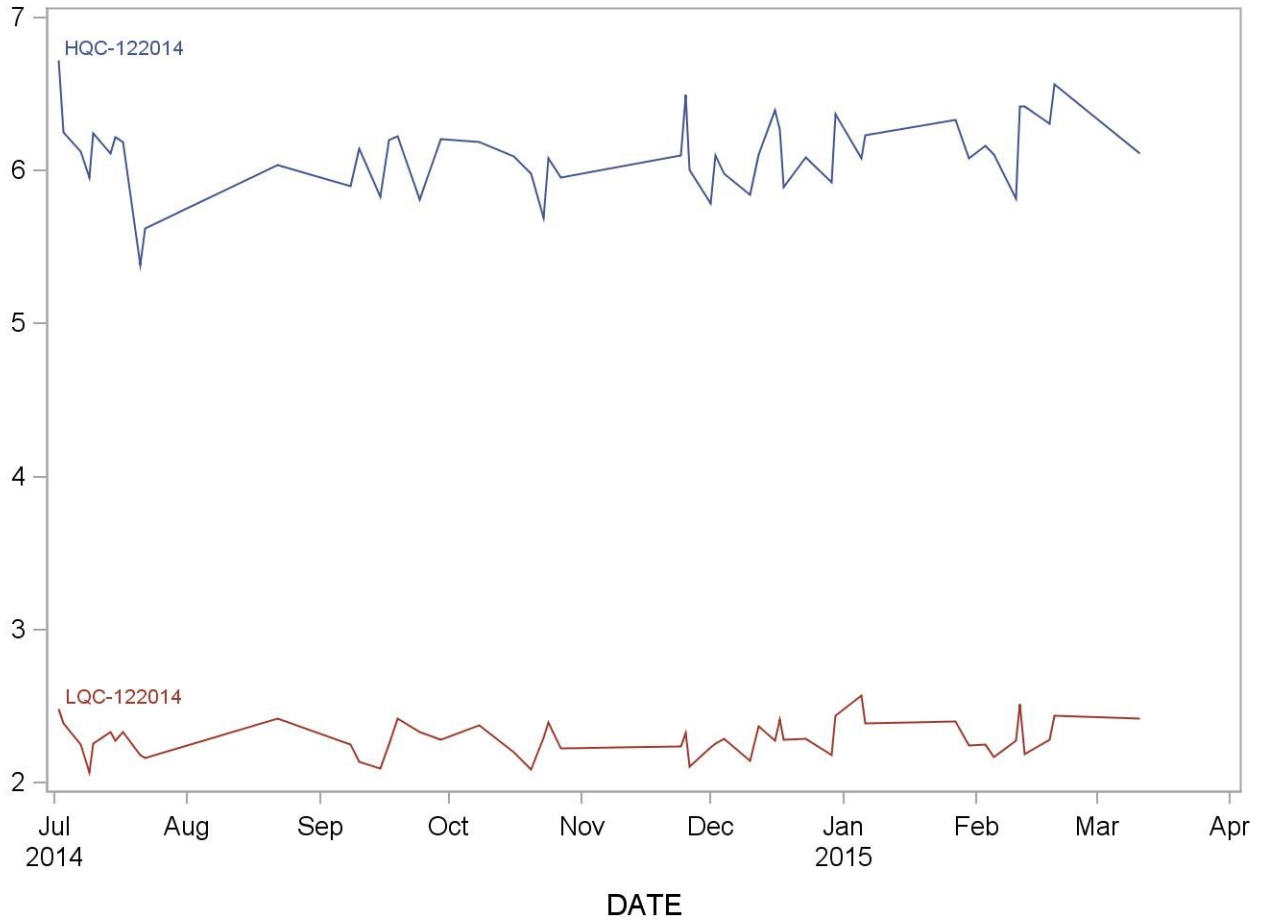

**2013–2014 Summary Statistics and QC Chart for Perfluorononanoic acid (ng/mL)**

Lot	N	Start Date	End Date	Mean	Standard Deviation	Coefficient of Variation
HQC-122014	50	02JUL14	11MAR15	6.3701	0.3081	4.8
LQC-122014	50	02JUL14	11MAR15	2.3770	0.1517	6.4

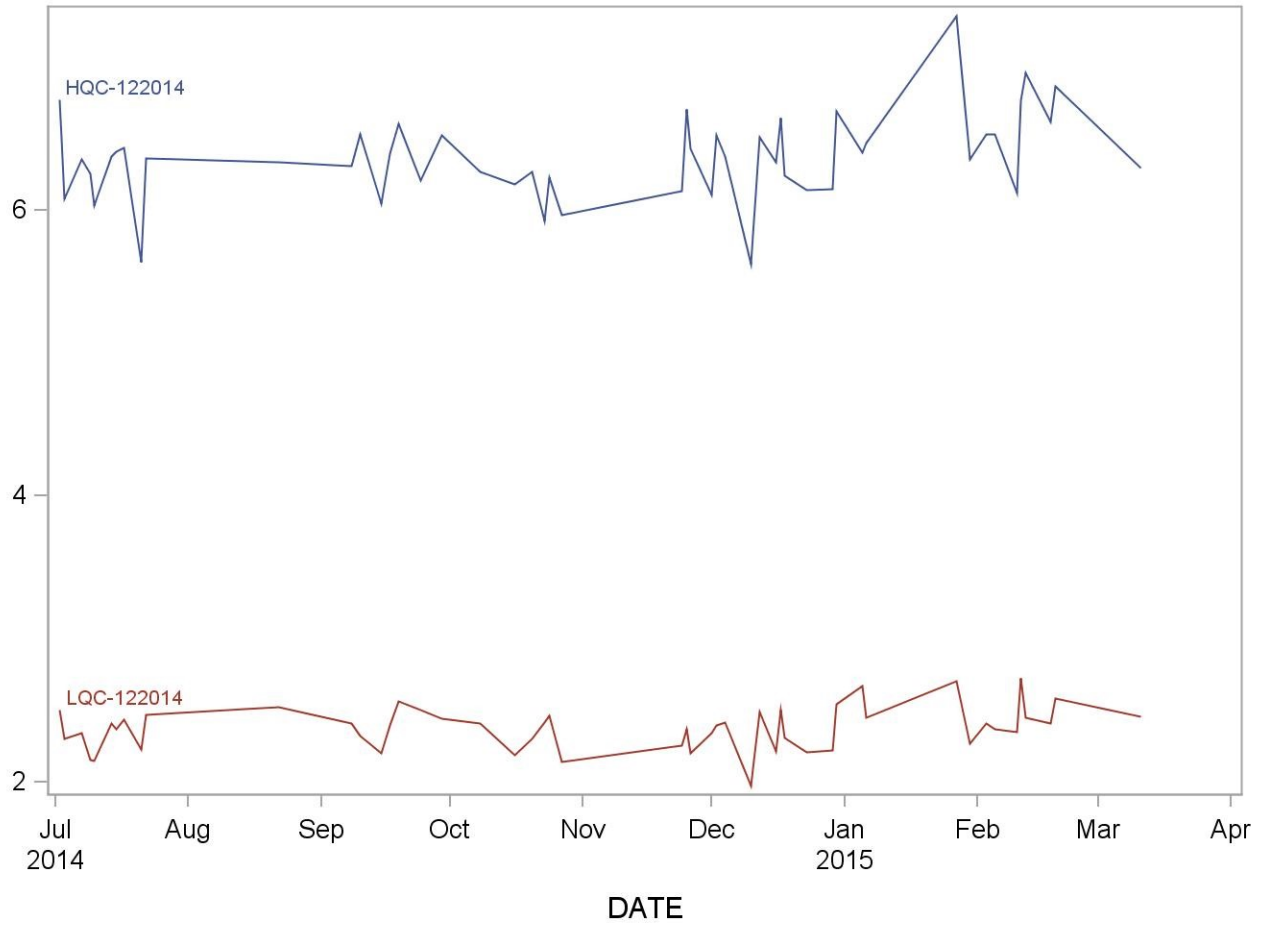

2013–2014 Summary Statistics and QC Chart for Perfluoroundecanoic acid (ng/mL)

Lot	N	Start Date	End Date	Mean	Standard Deviation	Coefficient of Variation
HQC-122014	50	02JUL14	11MAR15	6.223	0.297	4.8
LQC-122014	50	02JUL14	11MAR15	2.364	0.145	6.1

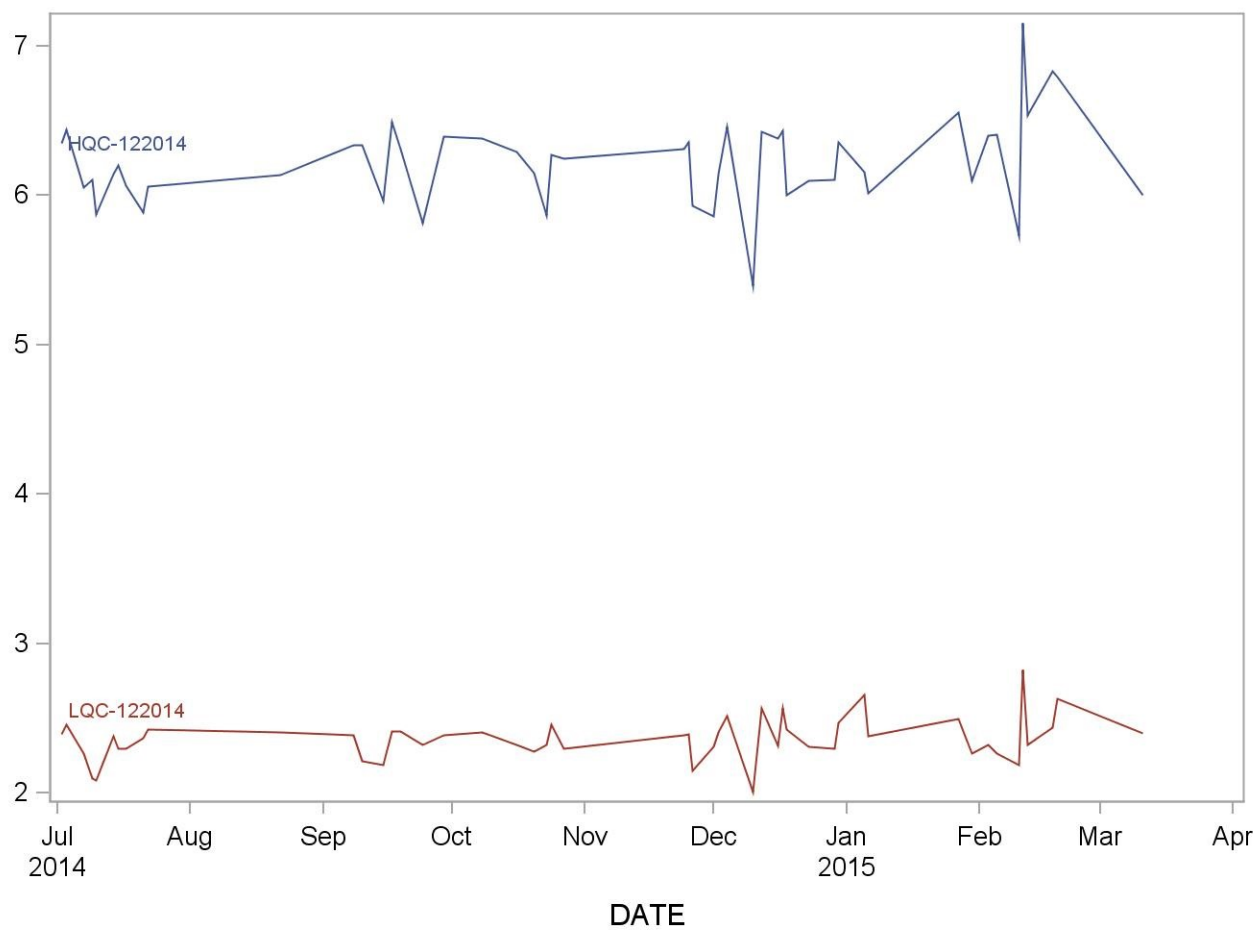

## References

1. Houde, M.; Martin, J. W.; Letcher, R. J.; Solomon, K. R.; Muir, D. C. G. Biological monitoring of polyfluoroalkyl substances: A review. *Environ. Sci. Technol.* **2006**, *40* (11), 3463-3473.
2. Calafat, A. M.; Needham, L. L.; Kuklennyik, Z.; Reidy, J. A.; Tully, J. S.; Aguilar-Villalobos, M.; Naeher, L. P. Perfluorinated chemicals in selected residents of the American continent. *Chemosphere* **2006**, *63* (3), 490-496.
3. Guruge, K. S.; Taniyasu, S.; Yamashita, N.; Wijeratna, S.; Mohotti, K. M.; Seneviratne, H. R.; Kannan, K.; Yamanaka, N.; Miyazaki, S. Perfluorinated organic compounds in human blood serum and seminal plasma: a study of urban and rural tea worker populations in Sri Lanka. *J. Environ. Monit.* **2005**, *7* (4), 371-377.
4. Olsen, G. W.; Huang, H. Y.; Helzlsouer, K. J.; Hansen, K. J.; Butenhoff, J. L.; Mandel, J. H. Historical comparison of perfluorooctanesulfonate, perfluorooctanoate, and other fluorochemicals in human blood. *Environ. Health Perspect.* **2005**, *113* (5), 539-545.
5. Taniyasu, S.; Kannan, K.; Horii, Y.; Hanari, N.; Yamashita, N. A survey of perfluorooctane sulfonate and related perfluorinated organic compounds in water, fish, birds, and humans from Japan. *Environ. Sci. Technol.* **2003**, *37* (12), 2634-2639.
6. Yeung, L. W. Y.; So, M. K.; Jiang, G. B.; Taniyasu, S.; Yamashita, N.; Song, M. Y.; Wu, Y. N.; Li, J. G.; Giesy, J. P.; Guruge, K. S.; Lam, P. K. S. Perfluorooctanesulfonate and related fluorochemicals in human blood samples from China. *Environ. Sci. Technol.* **2006**, *40* (3), 715-720.
7. Karrman, A.; Mueller, J. F.; van Bavel, B.; Harden, F.; Toms, L. M. L.; Lindstrom, G. Levels of 12 perfluorinated chemicals in pooled Australian serum, collected 2002-2003, in relation to age, gender, and region. *Environ. Sci. Technol.* **2006**, *40* (12), 3742-3748.
8. Harada, K.; Koizumi, A.; Saito, N.; Inoue, K.; Yoshinaga, T.; Date, C.; Fujii, S.; Hachiya, N.; Hirose, I.; Koda, S.; Kusaka, Y.; Murata, K.; Omae, K.; Shimbo, S.; Takenaka, K.; Takeshita, T.; Todoriki, H.; Wada, Y.; Watanabe, T.; Ikeda, M. Historical and geographical aspects of the increasing perfluorooctanoate and perfluorooctane sulfonate contamination in human serum in Japan. *Chemosphere* **2007**, *66* (2), 293-301.
9. Calafat, A. M.; Kuklennyik, Z.; Reidy, J. A.; Caudill, S. P.; Tully, J. S.; Needham, L. L. Serum concentrations of 11 polyfluoroalkyl compounds in the US population: Data from the National Health and Nutrition Examination Survey (NHANES) 1999-2000. *Environ. Sci. Technol.* **2007**, *41* (7), 2237-2242.
10. Fromme, H.; Midasch, O.; Twardella, D.; Angerer, J.; Boehmer, S.; Liebl, B. Occurrence of perfluorinated substances in an adult German population in southern Bavaria. *Int. Arch. Occup. Environ. Health* **2007**, *80* (4), 313-319.

11. Hansen, K. J.; Clemen, L. A.; Ellefson, M. E.; Johnson, H. O. Compound-specific, quantitative characterization of organic: Fluorochemicals in biological matrices. *Environ. Sci. Technol.* **2001**, *35* (4), 766-770.
12. Kannan, K.; Corsolini, S.; Falandysz, J.; Fillmann, G.; Kumar, K. S.; Loganathan, B. G.; Mohd, M. A.; Olivero, J.; Van Wouwe, N.; Yang, J. H.; Aldous, K. M. Perfluorooctanesulfonate and related fluorochemicals in human blood from several countries. *Environ. Sci. Technol.* **2004**, *38* (17), 4489-4495.
13. Calafat, A. M.; Wong, L. Y.; Kuklennyik, Z.; Reidy, J. A.; Needham, L. L. Polyfluoroalkyl chemicals in the US population: Data from the National Health and Nutrition Examination Survey (NHANES) 2003-2004 and comparisons with NHANES 1999-2000. *Environ. Health Perspect.* **2007**, *115* (11), 1596-1602.
14. Olsen, G. W.; Mair, D. C.; Church, T. R.; Ellefson, M. E.; Reagen, W. K.; Boyd, T. M.; Herron, R. M.; Medhdizadehkashi, Z.; Nobilett, J. B.; Rios, J. A.; Butenhoff, J. L.; Zobel, L. R. Decline in perfluorooctanesulfonate and other polyfluoroalkyl chemicals in American Red Cross adult blood donors, 2000-2006. *Environ. Sci. Technol.* **2008**, *42* (13), 4989-4995.
15. Kennedy, G. L.; Butenhoff, J. L.; Olsen, G. W.; O'Connor, J. C.; Seacat, A. M.; Perkins, R. G.; Biegel, L. B.; Murphy, S. R.; Farrar, D. G. The toxicology of perfluorooctanoate. *Crit Rev. Toxicol.* **2004**, *34* (4), 351-384.
16. Lau, C.; Butenhoff, J. L.; Rogers, J. M. The developmental toxicity of perfluoroalkyl acids and their derivatives. *Toxicol. Appl. Pharmacol.* **2004**, *198* (2), 231-241.
17. OECD . Co-Operation on Existing Chemicals. Hazard assessment of perfluorooctane sulfonate (PFOS) and its salts. [<http://www.oecd.org/dataoecd/23/18/2382880.pdf>], 1-362. 2002. Organisation for Economic Co-operation and Development (OECD).
18. Butenhoff, J. L.; Kennedy, G. L.; Frame, S. R.; O'Connor, J. C.; York, R. G. The reproductive toxicology of ammonium perfluorooctanoate (APFO) in the rat. *Toxicology* **2004**, *196* (1-2), 95-116.
19. Luebker, D. J.; York, R. G.; Hansen, K. J.; Moore, J. A.; Butenhoff, J. L. Neonatal mortality from in utero exposure to perfluorooctanesulfonate (PFOS) in SpragueDawley rats: Dose-response, and biochemical and pharmacokinetic parameters. *Toxicology* **2005**, *215* (1-2), 149-169.
20. Salihovic, S.; Karrman, A.; Lindstrom, G.; Lind, P. M.; Lind, L.; van Bavel, B. A rapid method for the determination of perfluoroalkyl substances including structural isomers of perfluorooctane sulfonic acid in human serum using 96-well plates and column-switching ultra-high performance liquid chromatography tandem mass spectrometry. *J. Chromatogr. A* **2013**, *1305*, 164-170.

21. Kuklenyik, Z.; Needham, L. L.; Calafat, A. M. Measurement of 18 perfluorinated organic acids and amides in human serum using on-line solid-phase extraction. *Anal. Chem.* **2005**, *77* (18), 6085-6091.
22. Lindstrom, G.; Karrman, A.; van Bavel, B. Accuracy and precision in the determination of perfluorinated chemicals in human blood verified by interlaboratory comparisons. *J. Chromatogr. A* **2009**, *1216* (3), 394-400.
23. Van Leeuwen, S. P. J.; Karrman, A.; van Bavel, B.; De Boer, J.; Lindstrom, G. Struggle for quality in determination of perfluorinated contaminants in environmental and human samples. *Environ. Sci. Technol.* **2006**, *40* (24), 7854-7860.
24. Caudill, S. P.; Turner, W. E.; Patterson, D. G. Geometric mean estimation from pooled samples. *Chemosphere* **2007**, *69*, 371-380.
25. CDC. Fourth National Report on Human Exposure to Environmental Chemicals. Updated Tables, February 2015.  
[[http://www.cdc.gov/biomonitoring/pdf/FourthReport\\_UpdatedTables\\_Feb2015.pdf](http://www.cdc.gov/biomonitoring/pdf/FourthReport_UpdatedTables_Feb2015.pdf)].  
2015. Atlanta, GA, Centers for Disease Control and Prevention; National Center for Environmental Health; Division of Laboratory Sciences.

## PFAS Exposure Assessment: Know Your Audiences

### *Audience outreach materials for environmental exposures*

CDC developed these optional audience outreach materials with input from state health department communicators to help state and county health departments talk with communities about environmental exposure concerns. The outreach suggestions, originally developed to help with cancer cluster communication, were informed by risk communication principles such as those in CDC's Crisis and Emergency Risk Communication (CERC) (<https://emergency.cdc.gov/cerc/>) manual (<https://emergency.cdc.gov/cerc/manual/index.asp>) and health department experiences working with communities around high-emotion environmental concerns. For more information about how leaders can work with communities during public health crises, visit: <https://emergency.cdc.gov/erc/leaders.pdf>.

Although these materials are not specific to PFAS exposure, the basic principles of providing information in a transparent way, identifying affected audiences, and listening to community concerns may help health departments in talking with communities concerned about PFAS and other environmental exposures.

This section offers tips for communicating with communities and individuals most affected by environmental exposures:

- Community members, who are worried that they or their loved ones will be exposed or get sick;
- Media, that have found a compelling story;
- Elected officials, who react to constituents' needs;
- Physicians, who are often the first line of communication during an exposure;
- Community groups, who are concerned about a potential exposure; and
- Real estate agents, who work closely in communities and can have an unintentional impact on community morale.

## Community Members

---

### Suggested Action Steps for State/Local Health Department

CDC's Crisis and Emergency Risk Communication (CERC) (<https://emergency.cdc.gov/cerc/>) manual (<https://emergency.cdc.gov/cerc/manual/index.asp>) focuses on these steps:

- **Be first:** Crises are time-sensitive. Communicating information quickly is almost always important. For members of the public, the first source of information often becomes the preferred source.
- **Be Right:** Accuracy establishes credibility. Information can include what is known, what is not known, and what is being done to fill in the gaps.
- **Be Credible:** Honesty and truthfulness should not be compromised during crises.
- **Express Empathy:** Crises create harm, and the suffering should be acknowledged in words. Addressing what people are feeling, and the challenges they face, builds trust and rapport.
- **Promote Action:** Giving people meaningful things to do calms anxiety, helps restore order, and promotes a restored sense of control.
- **Show Respect:** Respectful communication is particularly important when people feel vulnerable.
  - Respectful communication promotes cooperation and rapport.

CERC provides more details and examples applicable to many kinds of outreach challenges. You can access it online [here](#).

### Suggestions for the First Contact

- Public health officials should be trained in risk communication techniques. Show empathy. Listen to the story. Provide local health information.

- Try to learn as much as possible about the concerns, and assess the degree of distress in the affected community.

### **Suggestions beyond the First Contact**

- Identify and proactively meet community stakeholders, including residents, key community leaders, and family members.
- Find the leaders who have the trust of the community—the people who are respected in the community.
- Let the community know you are listening.
- Provide plain-language, audience-appropriate materials.
- Address community concerns as specifically as possible.
  - What scientifically sound information is available about this specific exposure?
  - What are the causes and risk factors (if known)?
  - How can it be prevented (if possible)?

### **Example Tactics to Share Information with Community**

Plan and adapt your communication tactics to the specific needs of your audience.

- If you're dealing with people who use traditional media (e.g., newspapers, radio), don't rely on social media and other technology-based channels.
- Remain open, transparent, and aware of audience feedback.
- If your audience is already distrustful, be very clear. Ambiguous information may validate their distrust.
- Avoid speech or actions that frame the issue in terms of "them (community)" and "us (public servants)."

**Web Site:** It may be helpful to update your Web site regularly (e.g. weekly or bi-weekly, depending on interest) with baseline community health information and the latest news about the investigation. Share links to other credible sources.

**Community Panel:** If the investigation expands, perhaps consider engaging community leaders and stakeholders in a panel that will meet regularly with you to share community concerns and take information about the investigation back to the community. In communities where trust is already damaged, a panel sponsored by the health department may not be seen as credible or independent. If this is the case in your community, it may be helpful to engage existing community groups and community leaders to sponsor it and maintain regular, structured, two-way communication.

**Community Meetings:** Community meetings are one avenue of getting information to people. It may be helpful to have a skilled facilitator and culturally competent spokesperson. Example types of community meetings include the following (more than one type may be combined if appropriate):



Town-Hall Style	Station Style	Small Group
<ul style="list-style-type: none"> <li>▶ Public health officials lead this type of large group meeting. Community members can ask questions and make comments.</li> <li>▶ Town-hall meetings can relieve community stress and help community members understand that the health department is listening to their concerns.</li> <li>▶ Keep presentations short and use plain language.</li> <li>▶ Use a strong facilitator who will not allow any one audience member to dominate the conversation.</li> <li>▶ Have resources available at the meeting for people who need stress relief (e.g., mental health services).</li> </ul>	<ul style="list-style-type: none"> <li>▶ This type of meeting, more like a health fair, consists of different tables hosted by groups such as the health department or environmental protection agency, where one-on-one conversations can happen.</li> <li>▶ Sometimes this type of meeting is preferred because it is usually more equitable—no one person or group can dominate conversation.</li> <li>▶ If you choose this type of meeting, invite various stakeholders to host stations.</li> </ul>	<p>This type of meeting can occur around a table or in a home to keep community members informed and allow people to speak freely.</p>

## Media

### Example Action Steps for State/Local Health Department

- Identify media outlets serving affected areas. Create and maintain a media list so that it is available quickly for communication.
- Target media that have demonstrated concern or interest.
- Provide a media education toolkit with information on the type of exposure and related health effects, such as fact sheets, FAQs, and other materials.
- Keep media updated on the investigation's progress, but not preliminary findings before they are verified.
- Point media to credible health information about chemicals (e.g., ATSDR ToxPortal Web site: [www.atsdr.cdc.gov/substances/index.asp](http://www.atsdr.cdc.gov/substances/index.asp)).
- Update your Web site as a tool to provide timely information.
- Notify media of privacy laws, such as the Health Insurance Portability and Accountability Act (HIPAA) at the beginning of the investigation. Be extremely careful not to disclose personal medical information.

**SUGGESTED GOAL:** Provide ongoing accurate information and education to the community at large by working with the media.

- Be proactive with the press; reach out to them rather than waiting for their calls.
- Be aware of reporters' deadlines.

### Interview Suggestions

As much as possible, hold media interviews in person with local reporters. This will be an opportunity to build rapport.

### News Briefing Suggestions

Conduct news briefings focused on the circumstances of this investigation. Local and state health departments should work together to make sure that efforts are synchronized.

## General Suggestions

- Manage expectations. Clarify the scope and limitations (e.g., authority, financial, scientific) of the investigation. Preview the next steps.
- Explain the difference between correlation and causation.
- Be proactive. When possible, reach out to local media by using platforms that best suit your community, such as letters to the editor, op-eds, or editorial boards.
- Always have a backup. Keep another public information officer (PIO) or communication person updated on the status of the investigation so that he or she can step in if you are not available.
- Always be empathetic, even if the results seem to show nothing uncommon is happening. Persons and families being affected will not want to read or hear that nothing is wrong.
- Emphasize what is confirmed and what is possible. For example, although results may not tell us if the PFAS exposure and health effects are linked, contaminated water can still be cleaned.
- Keep track of each of your conversations with media and stakeholders (with dates). Also, keep a list of all the interested parties so that no one is left out when you have new information to share.
- Consider publishing your protocol online where all stakeholders can find it and can see the steps in this type of investigation.
- Make sure that you reach consensus with all subject matter experts involved in the investigation before you provide new information or before you translate data to a reporter. Be sure that your quotes are in line with the agency position and that you're not breaking protocol by making your statement.

## Suggestions for Corresponding with Reporters

- Always keep reporters updated about the status of their request. Establish expectations. If the analysis will take several weeks, check in periodically to let them know that you're still working on their request and to check for additional questions.
- Make sure reporters understand state health agency limitations.
  - Resources are limited, and at any given time the health department may be facing a variety of public health threats. Environmental investigations, like other public health issues, are complex.
  - Health departments should help communities develop a clear understanding of the issues, and the potential effectiveness of proposed solutions, before taking action. Communities and health departments can succeed if they set clear goals and target resource usage efficiently.
- Inform reporters why it would be damaging to the investigation to share any preliminary data or analysis and that public health officers will share information when it is complete.
  - **Example:** "Public health officers are working to check all the information and conclusions to ensure all appropriate steps are being taken. Sharing any information before this process is complete could result in inaccurate information being published, which would not benefit any of the parties involved."

### Suggestions for Dealing with Highly-Involved Reporters

- Always take the time to educate reporters on the issue.
- Return calls promptly.
- Be open and proactive. Let them know that your agency is doing all that it can do.
- Be empathetic.
- Have patience. Do not get frustrated on the phone or in a meeting. Impatience can make the reporter think they are close to breaking a story and that you are uncomfortable with it.
- Do not take an aggressive reporter's approach personally. Avoid falling into an "us" vs. "them" type of argument.

## Elected Officials

---

### Suggested Action Steps for State/Local Health Department

- Be an ACTIVE RESOURCE for elected officials and appropriate/affected agency heads (e.g., Environment, Public Works).
- Establish two-way communication. Keep them informed from the beginning.
- Be frank and direct; explain investigative steps and available statistics.
- Educate your legislative liaisons. Make sure that they are informed about environmental exposures and have the tools to talk with elected officials when the situation arises. Tell them where to go for answers.
- Share with them the potential outcomes of community outrage.
  - **Example:** “The reason we are coming to you is because people are afraid. Property values can be affected. This situation may lead to angry and hurt families who feel they cannot trust anyone. We want to make sure that they feel they can trust you and trust us.”
- Manage expectations. Make sure the elected officials are aware of long-term implications of their actions and statements. Advise them to refrain from making commitments they or the health department may not be able to keep.

**SUGGESTED GOAL:** Elected officials will understand the challenges and opportunities of the situation. With coaching, elected officials will become messengers of accurate information and help manage community expectations. Develop a relationship so they feel free to share information from constituents with the health department.

## Physicians

---

### Suggested Action Steps for State/Local Health Department

- Identify residents who are physicians or public health professionals who may be able to assist in education efforts and serve as credible sources of information. These are the sources that the media and others will seek out, so public health officers want to make sure they have accurate information. Help them understand the health department’s messaging.
- Consider a physician education package that would include:
  - A fact sheet
  - Peer reviewed literature, and
  - Suggestions on how to talk to patients and families about environmental exposures.

**SUGGESTED GOAL:** With sound information, area physicians will be credible sources for accurate information about risk.

- They can and will help families work through their feelings.
- Make sure physicians are getting accurate information.
- If you partner with physicians, coach them to provide a consistent, coordinated message.

## Community Groups

---

### Suggested Action Step for State/Local Health Department

- Create a list of respected community groups or stakeholders with an interest or stake in the issue.
- Include these groups in public outreach efforts. The groups are resources for the community and can provide emotional and educational support.
- Train health department subject matter experts to use empathy, plain language, and cultural competence in presentations and communication with community groups.

**SUGGESTED GOAL:** Build a trusted third party source of information for communities by partnering early with local groups to provide information, education, and perhaps counseling for community members.

- Clear, concise, open dialogue is integral to media relations.
- Community members tend to trust local and nonprofit groups.

## Real Estate Agents

---

### Suggested Action Steps for State/Local Health Department

- Compile a list of real estate agencies and organizations in the area.
- Provide data and informational materials to ensure that professional associations and real estate agents in the area have accurate information.
- Be available to answer questions.

**SUGGESTED GOAL:** Real estate agents or local agent associations will be able to explain the environmental investigation to potential buyers without escalating outrage. Real estate agents will be productive participants in community meetings and able to explain the potential effect on housing prices of an environmental investigation in the community.

# The family tree of per- and polyfluoroalkyl substances (PFAS) for environmental health professionals

## Names and abbreviations

This fact sheet tells you about chemical names within the family of per- and polyfluoroalkyl substances (PFAS) and their basic chemical structure. It also spells out abbreviations for common PFAS.

PFAS are a family of man-made chemicals that contain carbon, fluorine, and other elements.

The family tree image, Figure 1, shows some of the different families of PFAS. For simplicity, it does not include all PFAS subfamilies. Follow along – starting at the “fallen apple” of PFC and then continuing up the tree trunk into the branches.

## PFC

In the past, PFC stood for perfluorinated chemicals.

However, using the abbreviation PFC can be confusing. This abbreviation is also used to mean perfluorocarbons. Perfluorocarbons are a different family of chemicals, also known as greenhouse gases.

The term PFC has fallen off the family tree, but it remains in the diagram as a reminder of past use. You may still see informational materials using the term “PFC” instead of PFAS.

## PFAS

Current nomenclature favors “PFAS” which are per- and polyfluoroalkyl substances. The PFAS family includes hundreds of chemicals. See Table 1 (next page) for some abbreviations and chemical names.

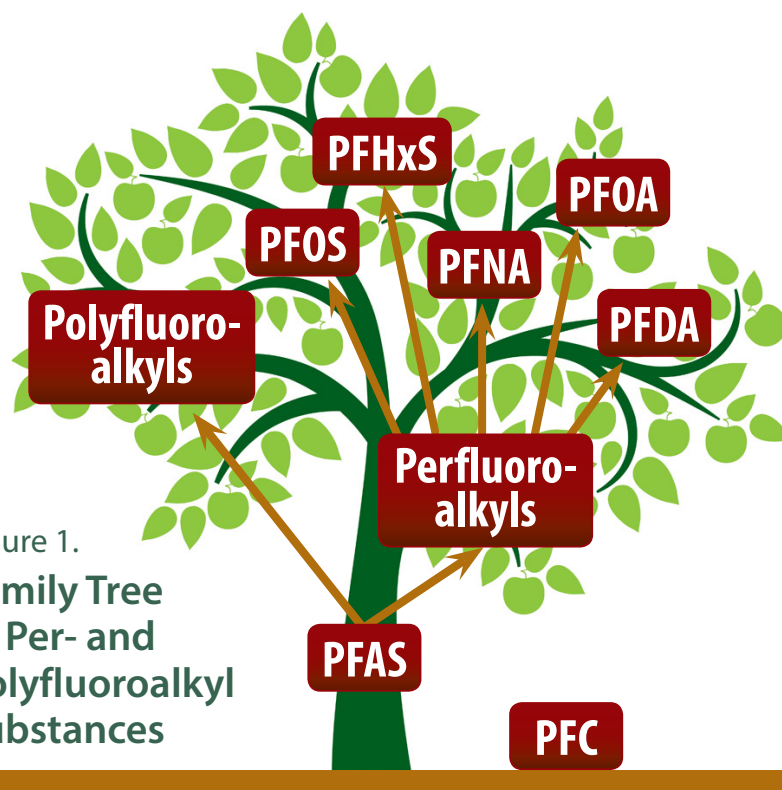

Figure 1.  
**Family Tree of Per- and polyfluoroalkyl Substances**

Table 1. Common PFAS: Abbreviations and Names

Abbreviation	Chemical name
PFOS	Perfluorooctane sulfonic acid
PFOA (aka C8)	Perfluorooctanoic acid
PFNA	Perfluorononanoic acid
PFDA	Perfluorodecanoic acid
PFOSA (aka FOSA)	Perfluorooctane sulfonamide
MeFOSAA (aka Me-PFOSA-AcOH)	2-(N-Methyl-perfluorooctane sulfonamido) acetic acid
Et-FOSAA (aka Et-PFOSA-AcOH)	2-(N-Ethyl-perfluorooctane sulfonamido) acetic acid
PFHxS	Perfluorohexane sulfonic acid

## Chemical Structure

All PFAS contain a chain of carbon atoms bonded to fluorine atoms. Some also have a functional group at the end of the chain. These structures are the basis for different chemical properties and different chemical names.

In perfluoroalkyl substances all carbons except the last one are attached to fluorines. The last carbon attaches to the functional group. See Figure 2.

In polyfluoroalkyl substances at least one (but not all) carbons are attached to fluorines.

Figure 2. **Perfluorooctanoic acid (PFOA), a perfluoroalkyl substance**

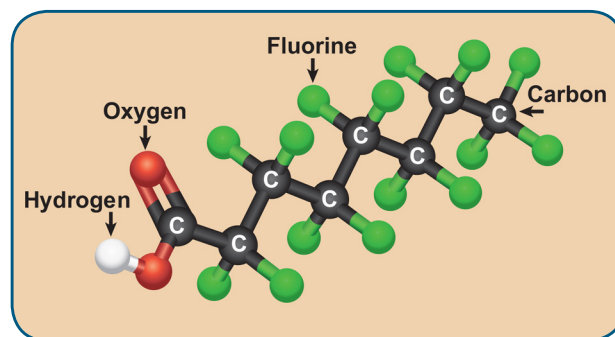

Image credit: NIEHS.

## Note about Plurals

PFAS is the abbreviation for per- and polyfluoroalkyl substances (plural), so you don't technically need another "s." You may see "PFASs" written, but ATSDR's preference is to use PFAS. When you write about PFAS make sure you use correct subject-verb agreement – PFAS is a plural noun, so it must be used with a plural verb. For example "These are the most common PFAS found in people."

You can also use the term "PFAS family" with a singular verb.

It may feel awkward to use PFAS as a plural when it sounds singular, but with practice, it will feel right.

## References

Buck et al 2011. *Perfluoroalkyl and Polyfluoroalkyl Substances in the Environment: Terminology, Classification, and Origins*. Integrated Environmental Assessment and Management. v7, (4), pp. 513–541.

CDC. 2009. *Fourth National Report on Human Exposure to Environmental Chemicals*. Atlanta, GA: Centers for Disease Control and Prevention. p. 247 – 257.

# The family tree of perfluoroalkyl and polyfluoroalkyl substances (PFAS)

## Names and abbreviations

This fact sheet tells you about chemical names within the family of perfluoroalkyl and polyfluoroalkyl substances (PFAS) and their basic chemical structure. It also spells out abbreviations for common PFAS.

PFAS are a family of man-made chemicals that contain carbon, fluorine, and other elements.

The family tree image below, Figure 1, shows some of the different families of PFAS. For simplicity, it does not include all PFAS subfamilies. Follow along – starting at the “fallen apple” of PFC and then continuing up the tree trunk into the branches.

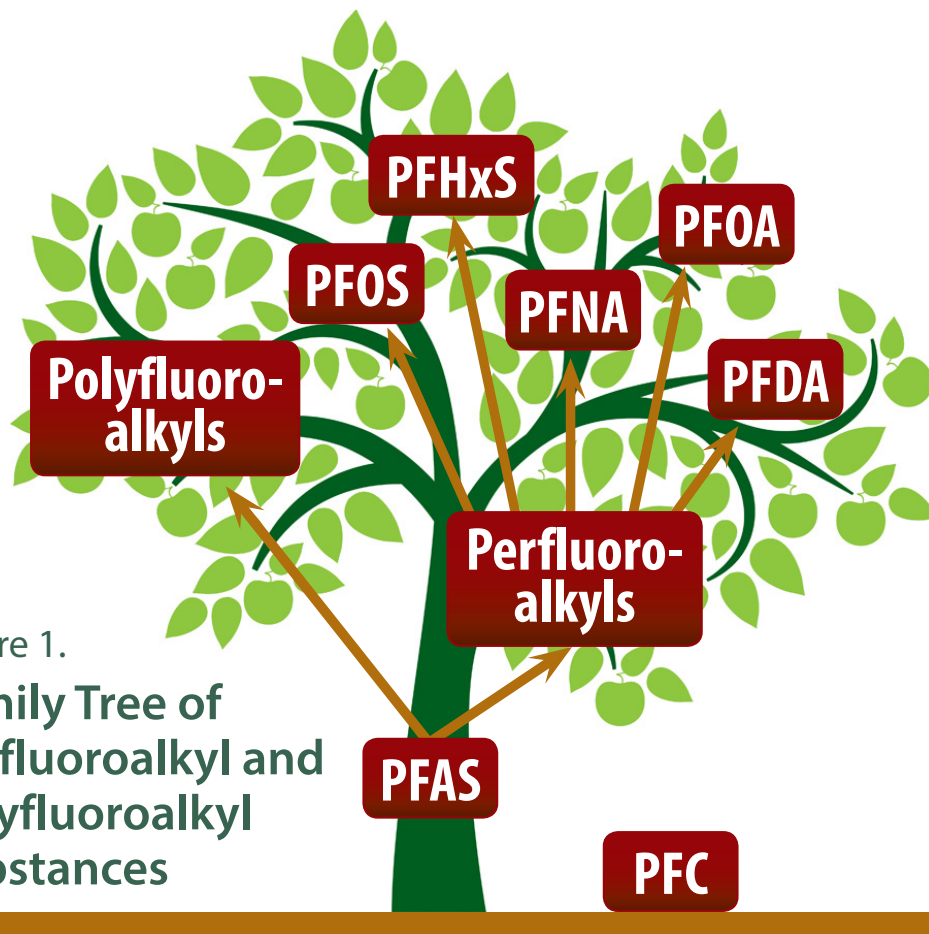

Figure 1.  
Family Tree of  
perfluoroalkyl and  
polyfluoroalkyl  
Substances

## PFC

In the past, scientists used the abbreviation PFC to stand for perfluorinated chemicals.

However, using the abbreviation PFC can be confusing because it is also an abbreviation for perfluorocarbons. Perfluorocarbons are an entirely different family of chemicals, also known as greenhouse gases.

The term PFC has fallen off the family tree, but it remains in the diagram as a reminder of past use. You may still see informational materials using the term “PFC” instead of PFAS.

## PFAS

Perfluoroalkyl substances and polyfluoroalkyl substances are called PFAS for short. The PFAS family includes hundreds of chemicals. The different structures of the PFAS molecules are the basis for different chemical properties and different chemical names. See Table 1 for abbreviations and chemical names.

Table 1. **Common PFAS: Abbreviations and Names**

Abbreviation	Chemical name
<b>PFOS</b>	Perfluorooctane sulfonic acid
<b>PFOA (aka C8)</b>	Perfluorooctanoic acid
<b>PFNA</b>	Perfluorononanoic acid
<b>PFDA</b>	Perfluorodecanoic acid
<b>PFOSA (aka FOSA)</b>	Perfluorooctane sulfonamide
<b>MeFOSAA (aka Me-PFOSA-AcOH)</b>	2-(N-Methyl-perfluorooctane sulfonamido) acetic acid
<b>Et-FOSAA (aka Et-PFOSA-AcOH)</b>	2-(N-Ethyl-perfluorooctane sulfonamido) acetic acid
<b>PFHxS</b>	Perfluorohexane sulfonic acid



# An Overview of Perfluoroalkyl and Polyfluoroalkyl Substances and Interim Guidance for Clinicians Responding to Patient Exposure Concerns

## Interim Guidance

Revised on 9/20/2016

### Introduction

The purpose of this fact sheet is to provide interim guidance to aid physicians and other clinicians with patient consultations on perfluoroalkyl and polyfluoroalkyl substances (PFAS). It highlights what PFAS are, which chemicals fall into this category of substances, identifies health effects associated with exposure to various PFAS, and suggests answers to specific patient questions about potential PFAS exposure.

### Background

#### What are PFAS?

PFAS, sometimes known as PFCs, are synthetic chemicals that do not occur naturally in the environment. There are many different types of PFAS such as perfluorocarboxylic acids (e.g., PFOA, sometimes called C8, and PFNA) and perfluorosulfonates (e.g., PFOS and PFHxS). PFAS may be used to keep food from sticking to cookware, to make sofas and carpets resistant to stains, to make clothes and mattresses more waterproof, and to make some food packaging resistant to grease absorption, as well as use in some firefighting materials. Because PFAS help reduce friction, they are also used in a variety of other industries, including aerospace, automotive, building and construction, and electronics.

#### Why are PFAS a possible health concern?

According to the U.S. Environmental Protection Agency (EPA), PFAS are considered emerging contaminants. An “emerging contaminant” is a chemical or material that is characterized by a perceived, potential, or real threat to human health or the environment or by a lack of published health standards.

PFAS are extremely persistent in the environment and resistant to typical environmental degradation processes. The pathway for dispersion of these chemicals appears to be long-range atmospheric and oceanic currents transport. Several PFAS and their potential precursors are ubiquitous in a variety of environments. Some long-chain PFAS bioaccumulate in animals and can enter the human food chain.

PFOS and PFOA are two of the most studied PFAS. Exposure to PFOA and PFOS is widespread and global. PFOS and PFOA also persist in the human body and are eliminated slowly. Both PFOS and PFOA can be found in blood, and at much lower levels in urine, breast milk and in umbilical cord blood.

PFOS and PFOA may pose potential adverse effects for human health given their potential toxicity, mobility, and bioaccumulation potential. The likelihood of adverse effects depends on several factors such as amount and concentration of PFAS ingested as well as the time span of exposure.

### Routes of Exposure and Health Effects

#### What are the main sources of exposure to PFAS?

For the general population, ingestion of PFAS is considered the major human exposure pathway. The major types of human exposure sources for PFAS include:

- Drinking contaminated water.
- Ingesting food contaminated with PFAS, such as certain types of fish and shellfish.
- Until recently, eating food packaged in materials containing PFAS (e.g., popcorn bags, fast food containers, and pizza boxes). Using PFAS compounds has been largely phased out of food packaging materials.
- Hand-to-mouth transfer from surfaces treated with PFAS-containing stain protectants, such as carpets, which is thought to be most significant for infants and toddlers.

- Workers in industries or activities that manufacture, manipulate or use products containing PFAS may be exposed to higher levels than the general population.

### **What are other low level exposure sources?**

Individuals can also be exposed by breathing air that contains dust contaminated with PFAS (from soil, carpets, upholstery, clothing, etc.), or from certain fabric sprays containing this substance.

Dermal exposure is a minor exposure pathway. Dermal absorption is slow and does not result in significant absorption.

### **What are the potential PFAS exposure risks to fetuses and children?**

Recent research evaluating possible health effects to fetuses from PFAS exposures have shown that developing fetuses can be exposed to PFAS when umbilical cord blood from their mothers crosses the placenta during pregnancy. It is important to note that different PFAS have varying levels of permeability to the placental barrier.

Newborns can be exposed to PFAS through breast milk. The level of neonatal exposure depends on the duration of breastfeeding. Older children may be exposed to PFAS through food and water, similar to adults. In addition, young children have a higher risk of exposure to PFAS from carpet cleaners and similar products, largely due to time spent lying and crawling on floors in their early years.

### **How long do PFAS remain in the body?**

PFAS with long carbon chains have estimated half-lives ranging from 2-9 years such as:

- PFOA 3 to 4 years
- PFOS 5 to 6 years
- PFHxS 8 to 9 years

### **What are exposure limits for PFAS in drinking water?**

The Environmental Protection Agency (EPA) has published a Lifetime Health Advisory (LTHA) recommending that the concentration of PFOA and PFOS in drinking water, either individually or combined, should not be greater than 70 parts per trillion (0.07 parts per billion). The LTHA concentrations do not represent definitive cut-offs between safe or unsafe conditions, but rather provide a margin of protection for individuals throughout their life from possible adverse health effects. EPA health advisories are non-regulatory recommendations and are not enforceable.

### **What are PFAS levels in the U.S. population?**

Most people in the United States and in other industrialized countries have measurable amounts of PFAS in their blood.

The National Health and Nutrition Examination Survey (NHANES) is a program conducted by the Centers for Disease Control and Prevention (CDC) to assess the health and nutritional status of adults and children in the United States. NHANES (2011–2012) measured the concentration of PFAS in the blood of a representative sample of the U.S. population (12 years of age and older). The average blood levels found were as follows:

- PFOA: 2.1 parts per billion, with 95% of the general population at or below 5.7 parts per billion
- PFOS: 6.3 parts per billion, with 95% of the general population at or below 21.7 parts per billion
- PFHxS: 1.3 parts per billion, with 95% of the general population at or below 5.4 parts per billion

In the last decade, major manufacturers of PFOA and PFOS related products joined EPA in a global stewardship program to phase out production of these agents by 2015. Based on data collected from previous NHANES

cycle years, levels of PFOA and PFOS are generally decreasing in the blood of the general population as a result of this important initiative.

### Health Studies

#### How can PFAS potentially affect human health?

Studies in humans and animals are inconsistent and inconclusive but suggest that certain PFAS may affect a variety of possible endpoints. Confirmatory research is needed.

Below are summaries of studies in animals and humans.

#### Animal Studies:

Adverse health effects have been demonstrated in animal studies, but these occurred at exposure levels higher than those found in most people. The main health effects observed were: enlargement and changes in the function of the liver, changes in hormone levels (e.g., reduced testosterone synthesis, potential to affect T<sub>4</sub> and TSH levels) and adverse developmental outcomes. Developmental and reproductive effects, including reduced birth weight, decreased gestational length, structural defects, delays in postnatal growth and development, increased neonatal mortality, and pregnancy loss have all been associated with prenatal rodent exposure to PFOS and PFOA.

#### Human Studies:

##### C8 Health Project

The C8 Health Project was a large epidemiological study conducted because drinking water in six water districts across two states near Parkersburg, West Virginia were contaminated by release of PFOA (also called C8) from the 1950s until 2002 (when the contamination was discovered). These releases migrated and contaminated the air, parts of the Ohio River, and ground water. The study included 69,030 persons ≥18 years of age. The C8 Science Panel analyzed study data and found probable links (as defined by litigation) between elevated PFOA blood levels and high cholesterol (hypercholesteremia), ulcerative colitis, thyroid function, testicular cancer, kidney cancer, preeclampsia, as well as elevated blood pressure during pregnancy. Residents in the area of these releases showed 500 percent higher PFOA-concentrations in blood compared to a representative U.S. population (i.e., NHANES).

**Table 1: Overview of C8 and Other Human Studies**

<b>Cholesterol</b>	Some epidemiological studies demonstrated statistically significant associations between serum PFOA and PFOS levels and total cholesterol in: <ul style="list-style-type: none"> <li>- workers exposed to PFAS, and</li> <li>- residents of communities with high levels of PFOA in the drinking water compared to NHANES data that is representative of the U.S. population.</li> </ul> Other studies have found no association between PFAS exposures and the total cholesterol levels.
<b>Uric acid</b>	Several studies have evaluated the possible association between serum PFOA and serum PFOS levels and uric acid. Significant associations were found between serum PFOA and uric acid levels at all evaluated exposure levels.
<b>Liver effects</b>	A number of human studies have used liver enzymes as biomarkers of possible liver effects. In occupational studies, no associations between liver enzymes and serum PFOA or PFOS levels were consistently found. A study of highly

	exposed residents demonstrated significant associations but the increase in liver enzymes was small and not considered to be biologically significant.
<b>Cancer</b>	<p>The International Agency for Research on Cancer (IARC) has classified PFOA as possibly carcinogenic and EPA has concluded that both PFOA and PFOS are possibly carcinogenic to humans.</p> <p>Some studies have found increases in prostate, kidney, and testicular cancers in workers exposed to PFAS and people living near a PFOA facility. Findings from other studies report otherwise and most did not control for other potential factors including heavy smoking. Additional research is needed to clarify if there is an association.</p>

Note: Additional studies have identified possible associations between ulcerative colitis, thyroid disease and pregnancy induced hypertension and higher exposure to PFAS.

**What health screenings were used in the C8 study?**

The C8 Medical Panel suggested health screening to evaluate the C8 study population that included blood tests for cholesterol, uric acid, thyroid hormones and liver function as well as other age or situationally appropriate screenings like blood pressure and urine protein measures. For individual patients exposed to PFAS who are not among the C8 study screening population, there are no official guidelines supporting health screening. However the tests listed above are well established in clinical medicine and may be a consideration to discuss with your patient based on the patient history, concerns and symptoms.

**What are potential health effects from prenatal PFAS exposure to fetuses?**

Multiple studies have reported an association between elevated maternal blood and cord blood concentrations of PFAS (primarily PFOS and PFOA) and decreased birth weight. Specifically, one meta-analysis suggests that each 1 ng/mL increase in prenatal PFOA levels is associated with up to 18.9 g reductions in birth weight (Johnson, 2014). Studies have also observed decreased birth weight with prenatal exposures to PFOS. The association between maternal PFAS level and decreased birth weight is not statistically significant across all studies. Further, the observed reduction in birth weight does not consistently equate with increased risk of a low birth weight (LBW) infant. Only one study revealed a statistically significant association between LBW risk and PFOS (Stein 2009); no studies have found a statistically significant association between LBW risk and PFOA.

Additional studies are needed to conclusively link the relationships between fetal PFAS exposure and health effects.

**Patient Questions and Key Message Answers**

As a clinician, you know careful listening and patient engagement is critical for ensuring quality patient care, especially when health concerns are raised. Perhaps the most difficult challenge in speaking with patients about their health concerns is addressing uncertainty. If your patient has concerns about an exposure to PFAS, you may face the challenge of helping your patient cope with the uncertainty of potential health effects from a PFAS exposure.

Based on feedback from clinicians and from individuals who have spoken to their health care provider about their PFAS exposure concerns, a set of patient questions have been identified. To assist you in speaking with your patients about their concerns, key messages and supporting facts needed to answer the anticipated patient questions are provided in the table below for your information and potential use.

**Table 2: Patient Questions and Key Message**

Questions Patients May Ask	Key Patient Messages	Key Message Supporting Facts
<p><b>There are high levels of PFAS in my water. What should I do?</b></p>	<p>If the water you use is above the EPA health advisory level for PFOA and PFOS, you can reduce exposure by using an alternative water source for drinking, food preparation, cooking, brushing teeth or any activity that might result in ingestion of water.</p>	<p>Potential health effects are associated with exposure to PFAS.</p> <p>EPA has established a lifetime health advisory for PFOA and PFOS in drinking water. This advisory states that the concentration of PFOA and PFOS in drinking water, either individually or combined, should not be greater than 70 parts per trillion.</p> <p>There needs to be additional research to establish levels of health risk, but patients may want to reduce exposures below the EPA health advisory level to be on the safe side.</p> <p>A home water filtration system can reduce the contaminant levels in drinking water. Researchers are still clarifying how to best use home filtration for PFAS contamination. Installing a home filtration system or using a pitcher-type filter may reduce PFAS levels. However, these filters may not reduce PFAS enough to meet the EPA Lifetime Health Advisory (LTHA) level. Three factors determine how much PFAS are removed by filtration. These factors are the PFAS contaminant levels, the type of filter, and how well the filter is maintained. Manufacturers of the filtration system may be able to make recommendations to optimize removal of PFAS. This may include more sophisticated media cartridges or increasing the frequency of exchanging filter media.</p> <p>For bottled water questions (how it is treated and if it is safe) contact the CFSAN Information Center at 1-888-SAFEFOOD (1-888-723-3366).</p>

Questions Patients May Ask	Key Patient Messages	Key Message Supporting Facts
<p><b>Could my health problems be caused by PFAS exposure?</b></p> <p><b>(Based on the health problems the patient has, there are two possible responses to this question.)</b></p> <p><b>(a)</b> If the patient’s health problem is in the list below, it may potentially be associated with PFAS exposure, based on limited evidence from human studies. The potential health effects include:</p> <ul style="list-style-type: none"> <li>- Thyroid function (potential to affect T<sub>4</sub> and TSH levels)</li> <li>- High cholesterol</li> <li>- Ulcerative colitis</li> <li>- Testicular cancer</li> <li>- Kidney cancer</li> <li>- Pregnancy-induced hypertension</li> <li>- Elevated liver enzymes</li> <li>- High uric acid</li> </ul> <p><b>(b)</b> If the patient’s health problem is not in the bulleted list above, then there is no current evidence that it is related to PFAS exposure. (However, research is ongoing and not all health outcomes have been adequately studied.)</p>	<p><b>(a)</b> Although the evidence is not conclusive, your health problem could potentially be associated with exposure to PFAS. However, health effects can be caused by many different factors, and there is no way to know if PFAS exposure has caused your health problem or made it worse.</p> <p><b>(b)</b> Based on what we know at this time, there is no reason to think your health problem is associated with exposure to PFAS.</p>	<p>For supporting facts on the listed health effects in this question <b>(a)</b>, see <b>“How can PFAS potentially affect human health.”</b> The information on potential illnesses and health effects will be briefly reviewed for each of these illnesses or health effects. This information can be found in this fact sheet on page 3 and 4.</p> <p>If your patient presents with health concerns that might be associated with PFAS exposure, it is appropriate to discuss the patient’s concerns and perform a thorough health and exposure history and also a physical exam relative to any symptoms reported.</p>
<p><b>Are there future health problems that might</b></p>	<p>We know PFAS can cause health issues but there is no conclusive</p>	<p>Studies in humans and animals are inconsistent and inconclusive but</p>

Questions Patients May Ask	Key Patient Messages	Key Message Supporting Facts
<p><b>occur because of PFAS exposure?</b></p>	<p>evidence that predicts PFAS exposure will result in future health problems. We can watch for symptoms related to PFAS associated health problems and investigate any that you notice, especially those that reoccur.</p>	<p>suggest that certain PFAS can cause possible health effects.</p> <p>Additional research is needed to better understand health risks associated with PFAS exposure.</p>
<p><b>Should I get a blood test for PFAS?</b></p>	<p>If you are concerned and choose to have your blood tested, test results will tell you how much of each PFAS is in your blood but it is unclear what the results mean in terms of possible health effects. The blood test will not provide information to pinpoint a health problem nor will it provide information for treatment. The blood test results will not predict or rule-out the development of future health problems related to a PFAS exposure.</p>	<p>There currently is no established PFAS blood level at which a health effect is known nor is there a level that predicts health problems. Most people in the US will have measureable amounts of PFAS in their blood. There are no health-based screening levels for specific PFAS that clinicians can compare to concentrations measured in blood samples. As a result, interpretation of measured PFAS concentrations in individuals is limited in its use. The patient may be aware of blood and urine test for PFAS being taken at other locations. These tests are used by public health officials to investigate community-wide exposure in order to understand the kinds and amounts of PFAS exposures in a community and how those exposures compare to those in other populations. Serum PFAS measurements are most helpful when they are part of a carefully designed research study.</p>
<p><b>What do my PFAS blood tests results mean?</b></p>	<p>The blood test for PFAS can only tell us the levels of specific PFAS in your body at the time you were tested.</p> <p>The blood tests results cannot be interpreted and used in patient care.</p> <p>The blood test results cannot predict or rule-out the development of future problems related to a suspected exposure.</p>	<p>There is currently no established PFAS blood level at which a health effect is known nor is there a level that is clearly associated with past or future health problems.</p> <p>The individual patient’s blood concentration of PFAS can only be compared to the average background blood concentration levels for different PFAS that are nationally identified through the representative sampling of the NHANES studies conducted by CDC.</p>

Questions Patients May Ask	Key Patient Messages	Key Message Supporting Facts
		<p>A patient’s PFAS concentrations can only show the patient if his or her blood levels are within range of the national norms or if the individual’s levels are high or low compared to the national background averages.</p>
<p><b>An adult patient asks:</b>  <b>“Should I be tested for any of the potential health effects associated with PFAS exposure (like cholesterol and uric acid levels, or liver and thyroid function, etc.)?”</b></p>	<p>Let’s look at your health history and past lab results and discuss what steps we may want to consider moving forward.</p> <p>One way we can address cholesterol is through your annual physical.</p> <p>For others PFAS associated conditions, we need to watch for symptoms and investigate any that you notice, especially those that reoccur.</p> <p>If any unusual symptoms occur, we will investigate those and treat as needed.</p> <p>Laboratory tests will not tell us if PFAS are the cause of any of your health symptoms or abnormal lab results, but conducting these routine health screenings and watching for any related symptoms do offer us a way to better understand your current health status.</p>	<p>Health effects associated with PFAS are not specific and can be caused by many other factors.</p> <p>There are no guidelines to support laboratory testing to monitor PFAS health concerns.</p> <p>However, if your patient is concerned about PFAS exposure, discussing routine cholesterol screening can reassure the patient that his or her PFAS exposure concerns are being addressed. Some of the other possible health effects can be screened for based on symptoms.</p>
<p><b>A parent asks:</b>  <b>“Should I have my child tested for any of the potential health effects associated with PFAS exposure (like cholesterol and uric acid levels, or liver, thyroid function, etc.)?”</b></p>	<p>The American Academy of Pediatrics has endorsed cholesterol testing for children starting at 9 years of age.</p> <p>Following this guidance cholesterol level testing can be done for older children.</p> <p>If cholesterol level measures are outside the normal range, we can discuss options for bringing cholesterol levels within the normal range for your child.</p> <p>For very young children, keeping well child visits is the</p>	<p>According to NHLBI guidelines endorsed by the American Academy of Pediatrics, all children should be screened for cholesterol levels between ages 9 and 11 years, and again between ages 17 and 21 years, even those who are not at an increased risk of high cholesterol and heart disease.</p> <p>Health effects associated with PFAS are not specific and can be caused by many other factors.</p>



Questions Patients May Ask	Key Patient Messages	Key Message Supporting Facts
	<p>best plan of action to monitor your child’s health and watch for symptoms of illness.</p> <p>We can discuss any symptoms you notice, especially those that reoccur.</p> <p>If any unusual symptoms occur, we will investigate those and treat as needed.</p> <p>Laboratory tests will not tell us if PFAS are the cause of any of your child’s health symptoms and are not recommended. Conducting routine well child visits and watching for any related symptoms do offer us a way to better understand your child’s current health status.</p>	<p>There are no guidelines to support use of laboratory testing to monitor PFAS health concerns.</p> <p>However, if your patient presents with health concerns that have been associated with PFAS exposures, discussing recommended cholesterol screening, can reassure the patient’s parents that their concerns are being addressed. Some of the other possible health effects can be screened for based on symptoms.</p>
<p><b>How will exposure to PFAS affect my pregnancy?</b></p>	<p>Exposure to PFAS before pregnancy has been associated with pregnancy-induced hypertension and pre-eclampsia.</p> <p>We will monitor your blood pressure closely, as we do for all pregnant women; however, there is no need for additional blood pressure measurements as a result of your exposure.</p>	<p>Health effects associated with PFAS are not specific and can be caused by many other factors.</p> <p>Pregnancy induced hypertension occurs in many pregnancies and the specific etiology is often unknown.</p>
<p><b>Is it safe for me to breastfeed my baby?</b></p>	<p>Breastfeeding is associated with numerous health benefits for infants and mothers.</p> <p>At this time, it is recommended that you as a nursing mother continue to breastfeed your baby.</p> <p>The science on the health effects of PFAS for mothers and babies is evolving.</p> <p>However, given the scientific understanding at this time, the benefits of breastfeeding your baby outweighs those of not breastfeeding.</p>	<p>Extensive research has documented the broad and compelling advantages of breastfeeding for infants, mothers, families, and society.</p> <p>Some of the many benefits include immunologic advantages, lower obesity rates, and greater cognitive development for the infant as well as a variety of health advantages for the lactating mother.</p> <p>Even though a number of environmental pollutants readily pass to the infant through human milk, the advantages of breastfeeding continue to greatly</p>

Questions Patients May Ask	Key Patient Messages	Key Message Supporting Facts
		outweigh the potential risks in nearly every circumstance.
<p><b>How will exposure to PFAS affect my child's immunizations?</b></p> <p><b>Will I need to get my child vaccinated again?</b></p>	<p>Although few studies have reported that PFOS and PFOA might slightly lower the immune response to some immunizations, these studies have not suggested a need to re-evaluate the normal immunization schedule.</p> <p>There is no recommendation for repeating any vaccinations.</p>	<p>A study with 656 children has reported that elevated levels of PFOA and PFOS in serum are associated with reduced humoral immune response to some routine childhood immunizations (rubella, tetanus and diphtheria) among children aged five to seven years.</p> <p>Studies have not suggested a need to re-evaluate the normal immunization schedule nor the use of an immunize booster for impacted children.</p>
<p><b>I have been very anxious about health risks from PFAS exposure. How can I deal with this uncertainty?</b></p>	<p>It is normal to be anxious about uncertain risks.</p> <p>I am here to listen to your questions and will do my best to provide honest answers.</p> <p>First let's identify ways to reduce ongoing exposures to PFAS so that overtime we can lower your health risks.</p> <p>Let's set up appointment for (X date) and we can discuss any new questions you have and check to see if there are any changes in how you feel.</p> <p>In the meantime, I have more information that may answer questions that you may have later about PFAS.</p>	<p>Listen sympathetically and explore the concerns of the patient</p> <p>Check for serious stress issues such as ongoing depression and treat accordingly.</p> <p>Review resources/references at the end of this fact sheet.</p>

## Resources

Below is a list of resources that can be helpful to clinicians. These include the Pediatric Environmental Health Specialty Units (PEHSU). The PEHSU are a national network of experts available to provide consultation and education to clinicians and communities wishing to learn more about PFAS and other hazardous substances. These units are staffed by clinicians with environmental health expertise in pediatrics, reproductive health, occupational and environmental medicine, medical toxicology, and other related areas of medicine.

Resource	Link
ATSDR: PFAS Overview Toxic Substance Portal ToxFAQs	<a href="http://www.atsdr.cdc.gov/pfc/index.html">http://www.atsdr.cdc.gov/pfc/index.html</a> <a href="http://www.atsdr.cdc.gov/substances/index.asp">http://www.atsdr.cdc.gov/substances/index.asp</a> <a href="http://www.atsdr.cdc.gov/toxfaqs/tf.asp?id=1116&amp;tid=237">http://www.atsdr.cdc.gov/toxfaqs/tf.asp?id=1116&amp;tid=237</a>
CDC: PFAS	<a href="https://www.cdc.gov/biomonitoring/PFAS_FactSheet.html">https://www.cdc.gov/biomonitoring/PFAS_FactSheet.html</a>
C8 Science Panel  C8 Medical Panel	<a href="http://www.c8sciencepanel.org/prob_link.html">http://www.c8sciencepanel.org/prob_link.html</a> <a href="http://www.c8sciencepanel.org/publications.html">http://www.c8sciencepanel.org/publications.html</a>  <a href="http://www.c-8medicalmonitoringprogram.com/">http://www.c-8medicalmonitoringprogram.com/</a> <a href="http://www.c-8medicalmonitoringprogram.com/docs/med_panel_education_doc.pdf">http://www.c-8medicalmonitoringprogram.com/docs/med_panel_education_doc.pdf</a>
EPA: PFAS	<a href="https://www.epa.gov/chemical-research/research-perfluorooctanoic-acid-pfoa-and-other-perfluorinated-chemicals-pfcs">https://www.epa.gov/chemical-research/research-perfluorooctanoic-acid-pfoa-and-other-perfluorinated-chemicals-pfcs</a>
IARC	<a href="http://www.iarc.fr/">http://www.iarc.fr/</a>
NIEHS: PFCs	<a href="https://www.niehs.nih.gov/health/materials/perflourinated_chemicals_508.pdf">https://www.niehs.nih.gov/health/materials/perflourinated_chemicals_508.pdf</a>
NHLBI Lipid Screening in Children & Adolescents	<a href="https://www.nhlbi.nih.gov/health-pro/guidelines/current/cardiovascular-health-pediatric-guidelines/full-report-chapter-9">https://www.nhlbi.nih.gov/health-pro/guidelines/current/cardiovascular-health-pediatric-guidelines/full-report-chapter-9</a>
PEHSU	<a href="http://www.pehsu.net/">http://www.pehsu.net/</a>
Uncertainty and Stress in the Clinical Setting	Helping Patients and Clinicians Manage Uncertainty During Clinical Care - <a href="https://publichealth.wustl.edu/helping-patients-and-clinicians-manage-uncertainty-during-clinical-care/">https://publichealth.wustl.edu/helping-patients-and-clinicians-manage-uncertainty-during-clinical-care/</a>  Navigating the Unknown: Shared Decision-Making in the Face of Uncertainty J Gen Intern Med. 2015 May; 30(5): 675–678. <a href="http://tinyurl.com/zrd587f">http://tinyurl.com/zrd587f</a>  Patient Health Questionnaire to determine if patient is suffering from depression. <a href="http://tinyurl.com/gv6h3wk">http://tinyurl.com/gv6h3wk</a>  Uncertainty Toolbox: Principles in the Approach to Uncertainty in the Clinical Encounter-J Gen Intern Med. 2015 May; 30(5): 675–678. <a href="http://tinyurl.com/gtlf2mk">http://tinyurl.com/gtlf2mk</a>

## Sources of Exposure

Toxicokinetics and  
Normal Human LevelsBiomarkers/Environmental  
LevelsToxGuide™  
for  
Perfluoroalkyls

July 2018

U.S. Department of Health and  
Human Services  
Public Health Service  
Agency for Toxic Substances  
and Disease Registry  
[www.atsdr.cdc.gov](http://www.atsdr.cdc.gov)

**Contact Information:**  
Division of Toxicology  
and Human Health Sciences  
Environmental Toxicology Branch

1600 Clifton Road NE, F-57  
Atlanta, GA 30329-4027  
1-800-CDC-INFO  
1-800-232-4636

[www.atsdr.cdc.gov/toxpro2.html](http://www.atsdr.cdc.gov/toxpro2.html)



## General Populations

- The major sources of exposure to perfluoroalkyls, especially PFOA and PFOS, are contaminated food and drinking water.
- Industrial releases of perfluoroalkyls into ambient air or surface water may also be a source of exposure for the general population.
- The general population may also be exposed to PFOS from carpets that have been mill treated to resist stains and to PFOA from migration from paper packaging and wrapping into food and inhalation from impregnated clothes.

## Occupational Populations

- The production of perfluoroalkyl and use of perfluoroalkyl containing products are sources of occupational exposure.

## Toxicokinetics

- Limited data indicate that perfluoroalkyls are absorbed from the respiratory tract. Studies in animals suggest that many perfluoroalkyls (including PFOA and PFOS) are almost completely absorbed from the gastrointestinal tract.
- The available data suggest that perfluoroalkyls are not metabolized nor do they undergo chemical reactions in the body.
- Perfluoroalkyls are primarily excreted in the urine.
- There are substantial differences in the elimination half-lives across perfluoroalkyl compounds and animal species. The estimated elimination half-lives in humans are 2.1-8.5 years for PFOA, 3.1-7.4 years for PFOS, 4.7-15.5 years for PFHxS, 2.5-4.3 years for PFNA, 665 hours for PFBuS, and 72-81 hours for PFBA. Much shorter half-lives have been estimated in experimental animals.

## Normal Human Levels

- Perfluoroalkyls appear to be ubiquitous in human blood based on the widespread detection of these substances in human serum samples.
- Geometric mean serum levels of PFOA, PFOS, PFHxS, and PFNA in the U.S. population ( $\geq 12$  years of age) were 1.94, 4.99, 1.35, and 0.675 ng/mL, respectively, and other perfluoroalkyls were generally  $< 1$  ng/mL.

## Biomarkers

- Measurement of serum or whole blood perfluoroalkyl concentrations is the standard accepted biomarkers of exposure to perfluoroalkyls.

## Environmental Levels

*Air*

- Mean PFOA levels ranged from 1.54-15.2 pg/m<sup>3</sup> in urban air samples in the U.S., Norway, and Japan. PFOS levels in ambient air are generally  $< 5$  pg/m<sup>3</sup> and levels of other perfluoroalkyls are generally  $< 1$  pg/m<sup>3</sup>.

*Water*

- Perfluoroalkyl levels in surface water samples are generally below 50 ng/L.

*Soil*

- Background levels of perfluoroalkyls in soil and sediment have not been located.

## Reference

Agency for Toxic Substances and Disease Registry (ATSDR). 2018. Toxicological Profile for Perfluoroalkyls (Draft for Public Comment). Atlanta, GA: U.S. Department of Health and Human Services, Public Health Service.

## Chemical and Physical Information

### Perfluoroalkyls are Solids or Liquids

- Perfluoroalkyls are a class of anthropogenic chemicals. There are a large number of perfluoroalkyl compounds; the toxicological profile discusses 14 of these compounds
- Perfluoroalkyls repel oil, grease, and water and have been used in surface protection products such as carpet and clothing treatments, coating for paper and cardboard packaging, and fire-fighting foams.
- Companies have stopped production of some perfluoroalkyls or have begun changing manufacturing practices to reduce releases and the amounts of these chemicals in their products.

### Selected Perfluoroalkyl Abbreviations

- PFBA = perfluorobutyric acid
- PFBuS = perfluorobutane sulfonic acid
- PFDeA = perfluorodecanoic acid
- PFDoA = perfluorododecanoic acid
- PFHpA = perfluoroheptanoic acid
- PFHxS = perfluorohexane sulfonic acid
- PFNA = perfluorononanoic acid
- PFOA = perfluorooctanoic acid
- PFOS = perfluorooctane sulfonic acid
- PFUA = perfluoroundecanoic acid

## Routes of Exposure

- Inhalation** – Most likely route of occupational exposure. Minor route of exposure for the general population.
- Oral** – Most likely route of exposure for the general population; food is expected to be the primary source.
- Dermal** – Potential route of exposure particularly among workers who handle perfluoroalkyl-treated products.

### Perfluoroalkyls in the Environment

- Perfluoroalkyls are very stable in the environment and are resistant to biodegradation, direct photolysis, atmospheric photooxidation, and hydrolysis.
- Perfluoroalkyls are persistent in water and soil. They are mobile in soil and leach into groundwater.
- Perfluoroalkyls biomagnify in the food web and the highest concentrations are found in apex predators. The bioaccumulation potential of perfluoroalkyls appears to increase with increasing chain length.

## Relevance to Public Health (Health Effects)

Health effects are determined by the dose (how much), the duration (how long), and the route of exposure.

### Minimal Risk Levels (MRLs)

#### Inhalation

- No acute-, intermediate-, or chronic-duration inhalation MRLs were derived for perfluoroalkyls.

#### Oral

- No acute-duration oral MRLs were derived for perfluoroalkyls.
- Intermediate-duration (15-365 days) provisional oral MRLs were derived for
  - PFOA:  $3 \times 10^{-6}$  mg/kg/day
  - PFOS:  $2 \times 10^{-6}$  mg/kg/day
  - PFHxS:  $2 \times 10^{-5}$  mg/kg/day
  - PFNA:  $3 \times 10^{-6}$  mg/kg/day
- No chronic-duration oral MRLs were derived for perfluoroalkyls.

### Health Effects

- A large number of studies have examined the possible relationship between levels of perfluoroalkyls in blood and adverse health effects in workers, highly exposed residents, and the general population. Although statistically significant associations have been found, the studies do not establish causality.

- The weight of evidence suggests links between perfluoroalkyl exposure and several health outcomes in humans: increases in serum lipids (PFOA, PFOS, PFNA, PFDeA), pregnancy-induced hypertension and/or pre-eclampsia (PFOA, PFOS), thyroid disease (PFOA, PFOS), decreased antibody response to vaccines (PFOA, PFOS, PFHxS, PFDeA), decreased fertility (PFOA, PFOS), and small decreases in birth weight (PFOA, PFOS).
- The primary effects observed in animals include liver toxicity (PFOA, PFOS, PFHxS, PFNA, PFDeA, PFUA, PFBA, PFBuS, PFDoA, PFHpA), developmental toxicity (PFOA, PFOS, PFHxS, PFNA, PFDeA, PFUA, PFBA) and immune toxicity (PFOA, PFOS). There are profound differences in the toxicokinetics and mode of action of perfluoroalkyls between humans and experimental animals. Many of the observed effects in animals result through the activation of peroxisome proliferator-activated receptor  $\alpha$  (PPAR- $\alpha$ ). Humans are much less responsive to PPAR- $\alpha$  than rodents and thus may not be as susceptible to these types of effects. However, some adverse effects of perfluoroalkyls occur through PPAR- $\alpha$ -independent mechanisms.

### Children's Health

- Children exposed to perfluoroalkyls would be expected to experience effects similar to those expected in adults.

## Environmental Protection Agency References

---

Guidance from the Environmental Protection Agency can be found at:

<https://www.epa.gov/pfas>.

This site includes:

- Method 537. Determination Of Selected Perfluorinated Alkyl Acids in Drinking Water by Solid Phase Extraction And Liquid Chromatography/Tandem Mass Spectrometry (Lc/Ms/Ms)
- Technical Advisory - Laboratory Analysis of Drinking Water Samples for Perfluorooctanoic Acid (PFOA) Using EPA Method 537 Rev. 1.1

## Appendix A: Potential PFAS-associated Health Conditions

The following list may not be all-inclusive but contains PFAS-associated health conditions or diseases from epidemiologic studies that have been published in the peer-reviewed and scientific literature. This literature base is sparse; most studies examined only a small number of PFAS, most often PFOA, PFOS, and less often, PFHxS and PFNA. Many are cross-sectional studies (done at a single point in time) and some provide conflicting evidence on the association between PFAS exposure and the adverse health effects or health conditions under study. Investigators can tailor their health conditions of interest (Section C) based on concerns from their communities, the conditions or diseases listed below, and the current scientific literature.

Health conditions/diseases	Question Bank
Attention Deficit Hyperactivity Disorder (ADHD)	Adult and Children
Chronic kidney disease, specify type:	Adults only
Coronary artery disease	Adults only
Endometriosis	Adults only
High blood pressure	Adults only
High cholesterol (high LDL-C)	Adult and Children
Hyperthyroidism	Adult and Children
Hypothyroidism	Adult and Children
Kidney cancer	Adults only
Liver disease (non-infectious)	Adults only
Multiple sclerosis	Adults only
Osteoarthritis	Adults only
Osteoporosis	Adults only
Pre-eclampsia	Adults, can be consider for adolescent participants
Pregnancy-induced hypertension	Adults, can be consider for adolescent participants
Prostate cancer	Adults only
Rheumatoid arthritis	Adults only
Stroke	Adults only
Testicular cancer	Adults only
Ulcerative colitis	Adults only

Example: Below is the example of health conditions by organ system for the health outcome section:

Organ System	Condition (add additional rows as needed)	Year diagnosed
Cardiovascular	High blood pressure	
	High cholesterol (high LDL-C)	
	Coronary artery disease	
	Other:	
Renal	Chronic Kidney Disease, Specify: _____	
	Other:	